

# High Purity Products

## MODEL 7100P

### PORTABLE OXYGEN ANALYZER - TRACE RANGE OPERATIONS MANUAL

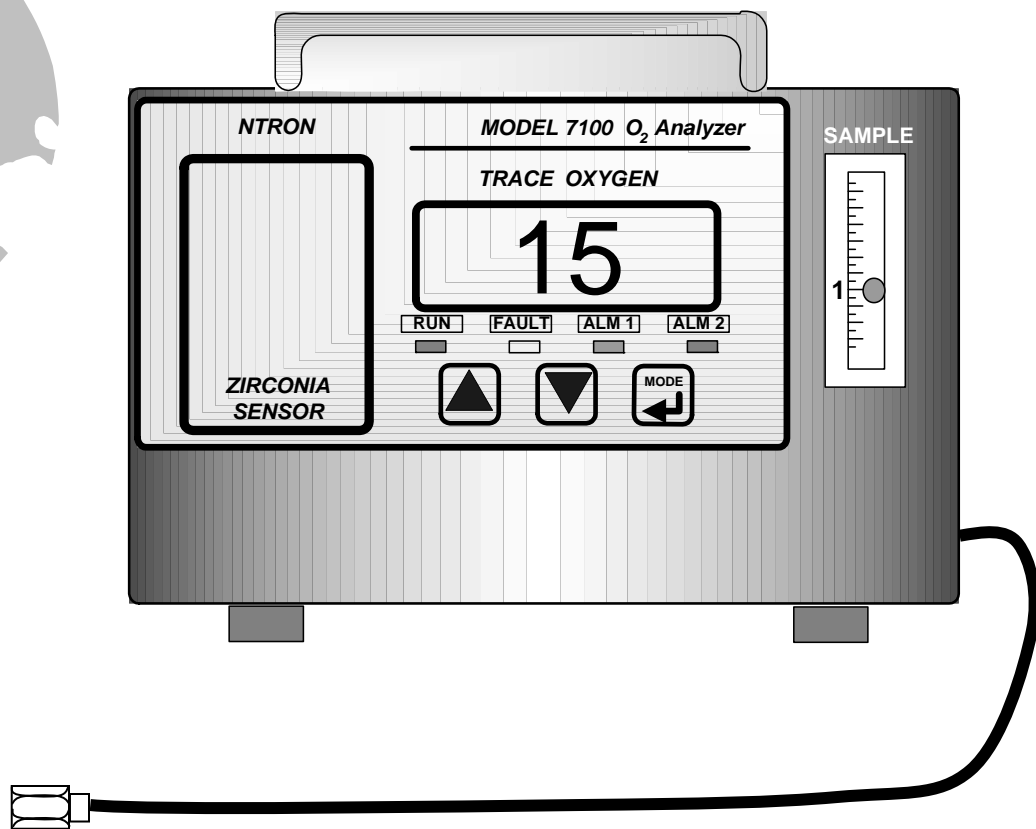

⋮

# Introduction

---

*Thank you for purchasing the Model 7100P Portable analyzer for PPM range oxygen measurement.*

The Model 7100P Portable analyzer is a user friendly, microprocessor controlled, oxygen measuring instrument. It has many features to offer the user which will be described in this manual. We recommend that all personnel who use this instrument read this manual to become more familiar with its proper operation.

For further detail regarding the maintenance and in-field service of the Model 7100P Portable analyzer, please contact the Neutronics Inc. Applications Engineering Department.

If you have questions or comments, we would like to hear from you.

Neutronics Inc. Customer Service Department

456 Creamery Way  
Exton, PA. USA 19341

Tel: (610) 524-8800  
Fax: (610) 524-8807  
EMAIL: industrial @ Neutronics Inc..com

visit us at .... [www.NeutronicsInc..com](http://www.NeutronicsInc..com)

Copyright © 2000 Neutronics Inc. Inc.

**Product Serial Number**

---

# Table of Contents

---

Introduction .....	2
For Your Safety .....	4
Specifications .....	5
Warranty and Intended Use .....	6
<b>Chapter 1 Principles of Operation</b>	
1.1 General .....	7
1.2 Features .....	8
1.3 System Components .....	9
1.4 System Configuration .....	14
<b>Chapter 2 Commissioning the Model 7100</b>	
<b>2.1 Installation</b> .....	<b>16</b>
2.1.1 Make Connections .....	17
<b>Solder Reflow</b> .....	<b>17</b>
<b>Metal, Wire, Ceramic Annealing</b> .....	<b>18</b>
<b>High Purity Welding</b> .....	<b>19</b>
<b>2.2 Start-Up</b> .....	<b>24</b>
2.2.1 Check List.....	24
2.2.2 Power Up .....	24
2.2.3 Calibration .....	25
2.2.4 Setting Alarms .....	26
2.2.5 Return to RUN .....	27
<b>Chapter 3 Modes of Operation</b>	
Mode Diagram .....	28
3.1 Run .....	29
3.2 Calibration .....	29
3.3 Set or View Alarm Values .....	32
3.4 Fault .....	34
3.5 Alarm Active Mode .....	34
<b>Chapter 4 Analog Outputs</b> .....	<b>35</b>
<b>Chapter 5 Alarm Outputs</b> .....	<b>36</b>
<b>Chapter 6 Serial Service Port (Using Windows 95 HyperTerminal.....</b>	<b>37</b>
<b>Chapter 7 Maintenance</b> .....	<b>41</b>
<b>Chapter 8 Trouble Shooting</b> .....	<b>42</b>
<b>Appendix A Spare Parts Listing</b> .....	<b>44</b>
<b>B MSDS</b> .....	<b>45</b>
<b>C Changing the Factory Settings.....</b>	<b>46</b>
<b>D Drawings</b> .....	<b>47</b>



## ***For Your Safety:***

### **PLEASE**

- ***READ THIS MANUAL IN ITS ENTIRETY BEFORE ATTEMPTING INSTALLATION OR OPERATION!***  
Attempting to operate the Model 7100P Portable analyzer without fully understanding its features and functions may result in unsafe conditions.
- Always use protective eye wear and observe proper safety procedures when working with pressurized gases.
- Always assure the pressure of gas entering the Model 7100P Portable analyzer is 1-3 psig.
- Always calibrate the Model 7100P Portable analyzer at an equivalent pressure and flow rate to the measured gas.
- Always allow the Model 7100P Portable analyzer sensor to cool down before attempting to access the sensor.
- Properly dispose of the oxygen sensor when it has expired.
- Ensure the MODEL 7100P Portable analyzer has been properly calibrated before use.
- Never expose the analyzer chassis or sensor to water, high humidity or moisture. The analyzer chassis is not watertight.
- Never expose the MODEL 7100P Portable analyzer to flame or high temperatures.
- Never expose the MODEL 7100P Portable analyzer directly to unregulated gas lines, cylinder gas, ... High gas pressures may cause the oxygen sensor to rupture.
- Ensure the analyzer unit is mounted in an area of free air flow to prevent the chassis from exceeding the operating temperature specifications. Do not mount the analyzer or sensor against hot surfaces. Do not block the ventilation louver on the analyzer chassis.
- The standard Model 7100P Portable analyzer is not explosion proof or Intrinsically Safe. Do not expose to flammable substances.
- ***Before powering up the model 7100P, it is important to purge the sensor of ambient air. This will facilitate a quick initial response to ppm levels of oxygen .*** The sensor used in the model 7100P Portable analyzer is designed for use in PPM concentrations of oxygen. If the analyzer is powered up while the sensor is exposed to ambient air, then the sensor will saturate with oxygen and may require up to 5 minutes recovery time once exposed to trace oxygen gases. To prevent this delay due to saturation, ***you should flow ppm level oxygen (or zero gas) to the sensor before power up.*** It takes approximately 5 seconds to sweep the sensor out when zero gas is swept through the analyzer. Then you can apply power to the analyzer. Exposure to air does not affect the life of the sensor. Likewise, also flow ppm level oxygen to sensor for 5 seconds after power off.

### **COPYRIGHT NOTICE:**

Copyright © 2001 Neutronics Inc. Inc.

This work is protected under Title 17 of the US Code and is the sole property of Neutronics Inc. Inc. No part of this document may be copied or otherwise reproduced, or stored in any electronic information retrieval system, except as specifically permitted under US copyright law, without the prior written consent of Neutronics Inc. Inc.

# Figure 1 Model 7100 Specifications

January 2001, Rev. 1

<b>Sensor Type:</b>	Mini-Zirconia Oxygen Sensor with Integral Heater.
<b>Measurement</b>	0-10ppm /0-100ppm / 0-2000ppm oxygen. May be set to auto range or to a fixed range.
<b>Display:</b>	0.75" LED digital display. Resolution: 0-9.9ppm : X.X, otherwise XX Color Coded LEDs for system status: Alarms 1 & 2 = <b>Red</b> , System Fault = <b>Yellow</b> , System OK & on-line = <b>Green</b>
<b>Signal Interface</b>	<b>Serial Service Port: RS-232 Computer Communications</b> of the following data: Oxygen Concentration, alarm settings/status, Fault status <b>Analog Outputs:</b> Voltage, 0-1 VDC or 0-5VDC or 0-10VDC +/- 0.5% @ 1K input min. Non-isolated 4-20 mA: +/- 0.5% , negative ground (loop is powered by analyzer) maximum loop impedance 500Ω. Range ID Voltage output
<b>Alarm Outputs, optional</b>	Relay dry contacts rated 5Amp @ 250 VAC, 5 AMP @ 30 VDC Alarm 1 & Alarm 2: Field adjustable Form C, Configurable for Fail Safe or Fail Alarm mode, Ascending or Descending trip. Fault alarm: 1 Form B . Status LEDs for each alarm.
<b>Response Time:</b>	< 15 seconds for 90% response due to step change in ppm oxygen @ 1 SCFH flow; approximately 5 minutes to less than 10 ppm from cold start after exposure to air
<b>Accuracy:</b>	± 2 PPM at 0-50 PPM Oxygen ± 3 PPM at 51- 500 PPM Oxygen ± 10 PPM at 501- 2000 PPM Oxygen * Enhanced accuracy when two point calibration at 500-700 ppm O <sub>2</sub> & at 5-10 ppm O <sub>2</sub>
<b>Warm up Time:</b>	Approximately 5 minutes to reach thermal equilibrium with ambient temperature.
<b>Power:</b>	90-250 VAC,50/60 Hz., Single Phase USA or Euro Style
<b>Sample Port:</b>	1/8 inch Swagelok with SS sample tube for sample inlet
<b>Operating Temperature:</b>	5° to 40° C (31 - 104° F)
<b>Storage Temperature:</b>	-15° to 50° C (5 - 122° F)
<b>Humidity:</b>	0-95% non-condensing
<b>Warranty:</b>	Analyzer & sensor: 12 months from date of shipment under normal operation.
<b>Operating Flow</b>	Sensor Flow: 0.7 to 1.2 SCFH; Total Flow: 1 SLPM
<b>Pressure</b>	Pressure Range: 5" Hg. Column Gage Vacuum to 5 PSIG Positive Pressure
<b>Sample Pump:</b>	Neoprene diaphragm and valves, brushless vdc motor, plastic head
<b>Weight:</b>	Less than 6 Lbs.
<b>Mechanical:</b>	<b>9.10 inches wide x 7.27 inches deep x 7.15 inches high; less than 6 lbs. weight</b>

Neutronics Inc., whose policy is one of continuous improvements, reserves the right to change specifications and this operation manual's content without notice.

**Revision 1, January 2001**

# NTRON Division Warranty Statement

*Neutronics Inc. warrants to the original purchaser, that the Model 7100P Portable analyzer to be free of defects in material and workmanship for a period of one (1) year from the date of shipment from Neutronics Inc. or from one of Neutronics Inc.'s authorized dealers. Our liability will be limited to the repair or replacement, at our factory, of parts found to be defective within the warranty period, as determined by Neutronics Inc.. The parts will be repaired or replaced free of charge if shipped prepaid to the factory in the original shipping carton. This warranty is void if the product has been subject to misuse or abuse, including but not limited to: exposure to water, humidity- temperature- shock or pressure outside of the listed specifications, or has not been operated in accordance with operating and maintenance instructions, for repairs which were not performed by Neutronics Inc. or by one of its authorized dealers, or if the identifying markings on the product label have been altered or removed.*

*The seller assumes no liability for consequential damages of any kind, and the buyer, by acceptance through purchase of this product, will assume all liability for the consequences of its use or misuse by the buyer, his employees, or others.*

*Neutronics Inc. reserves the right to use any materials in the manufacture, repair or service of the products and to modify the design as deemed suitable, in so far as these materials or modifications maintain the stated warranty.*

*It is the sole responsibility of the buyer / user to determine if this product is suitable for the intended application.*

THESE WARRANTIES ARE EXCLUSIVE AND IN LIEU OF ALL OTHER WARRANTIES, EXPRESSED, OR IMPLIED INCLUDING WARRANTY OF MERCHANTABILITY, FITNESS FOR A PARTICULAR PURPOSE .

## **Intended Use and Important Notes for the Application of the Model 7100P**

The model 7100P Portable analyzer was designed to provide the trained operator with useful information relating to the concentration of oxygen. This information may be used in process control or to minimize possible hazardous conditions which may be present in various processes. Before implementation, the user must fully understand the operation and limitations of this instrument as well as the application for its use. The responsibility for the proper installation, application, operation, and maintenance of the model 7100P Portable analyzer is the sole obligation of the trained operator. The purchaser is required to ensure operators are properly trained in the use of this unit as well as in the possible hazards associated with its use or with the intended application. The purchaser must ensure that all of the proper warnings, labels, instruction manuals, lock outs, redundant components, hazard analysis, and system validation have been completed and provided to the trained operator before implementation of the model 7100P Portable analyzer

# CHAPTER 1

## Principles of Operation

### 1.1 General

The Model 7100P Portable analyzer by NTRON Division offers a cost effective solution in a small package for oxygen measurement and control applications. The Model 7100P Portable analyzer is a microprocessor based instrument designed to accurately measure PPM range oxygen. It is ideally suited for measuring trace levels of oxygen in applications including High Purity Welding, Solder Reflow, Metal Annealing, semiconductor furnaces, glass manufacture, and inert atmosphere chambers.

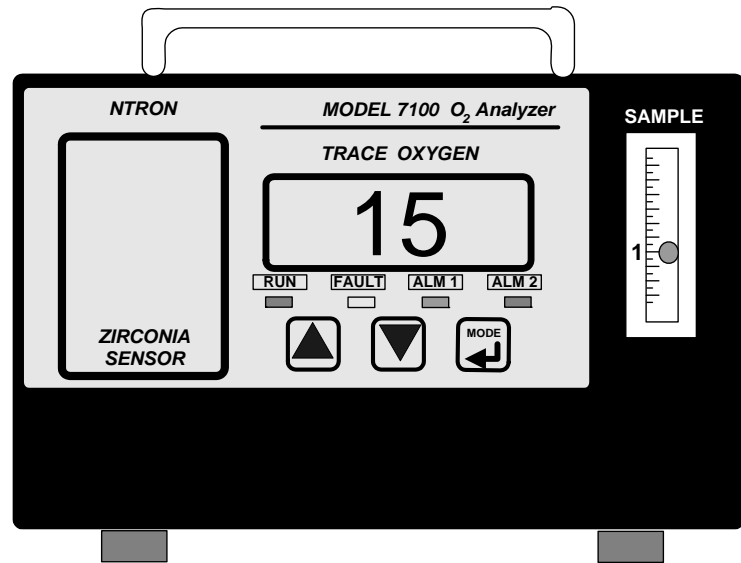

At the heart of the analyzer is a Neutronics Inc. micro-Zirconia ceramic oxygen sensor. The Zirconia sensor is a solid state device which assures reliability and fast response for critical measurements. Another advantage is since the sensor is a solid state device, it is unaffected by dry atmospheres, is undamaged by extremely cold storage temperatures (or power down situations in cold environments), and has indefinite storage life.

**Figure 2**

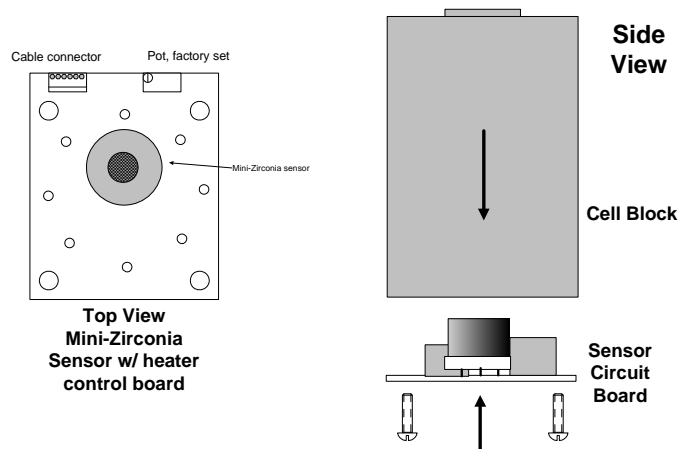

**1.2 Features:** The Model 7100P is designed to be portable for convenient use in the field. It requires connection to VAC power. There are two models available to meet power requirements of North America and for Europe. Provided with the 7100P is a Stainless Steel Sample tube with 1/8 inch Swagelok connection.

**Figure 3** Main Features of the Model 7100P Portable analyzer :

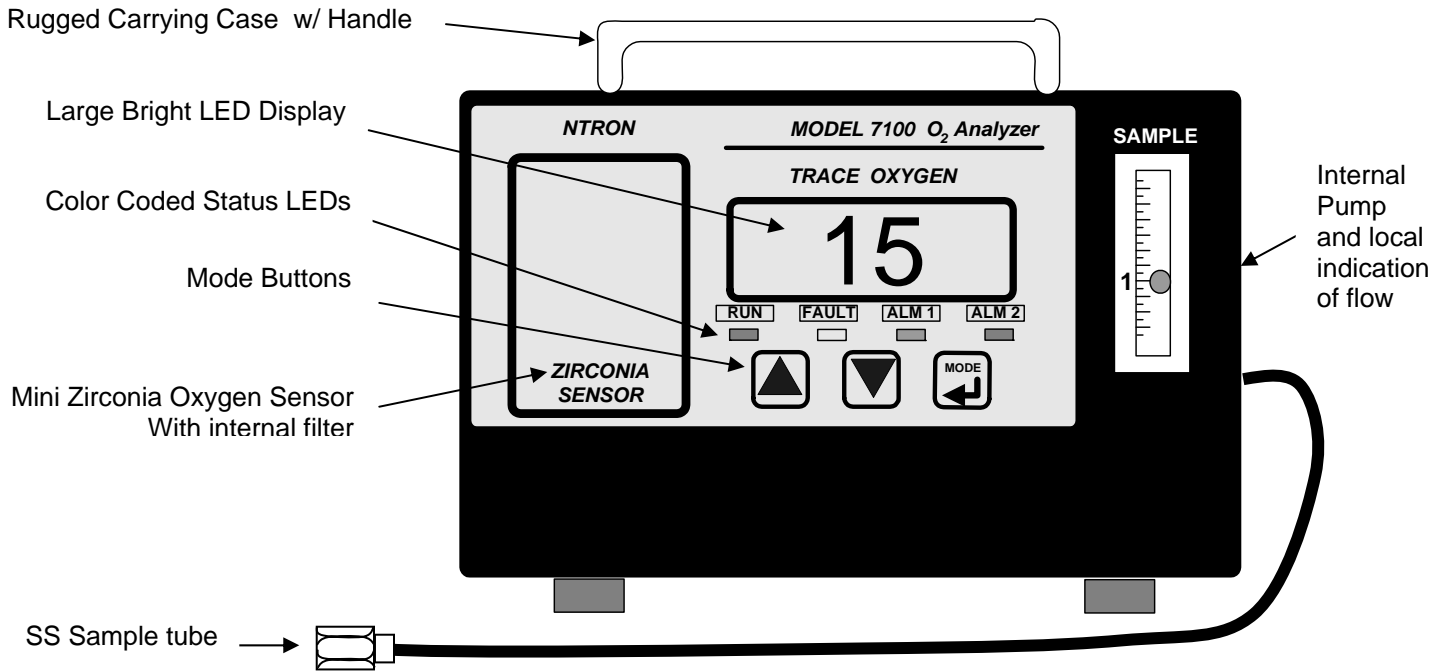

**Other Features Include:**

- Auto Ranging or Fixed Range Oxygen Measurement
- Bi-Directional Service Port for RS-232 serial interface for connection to a PC, terminal, or printer.
- Two Analog Outputs: 4-20 mA negative ground AND 0-1, 0-5, or 0-10 VDC
- Optional Two Adjustable Alarms with Relay Contacts and a Fault Alarm Contact. The adjustable alarms may be configured fail-safe or Non fail-safe & as Ascending or Descending Trip
- Optional external filter packages for measurement in solder reflow or other industrial applications.



# 1.3 System Components

The basic components of the model 7100P Portable analyzer are shown below in Figure 4:

**Figure 4**

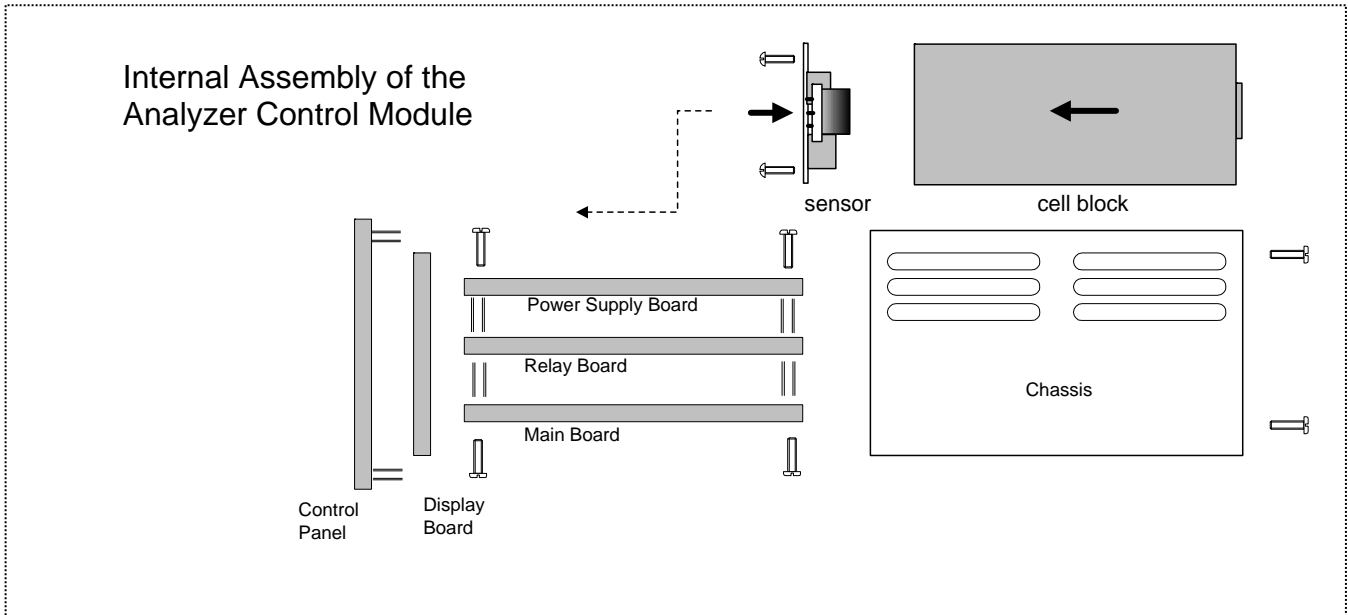
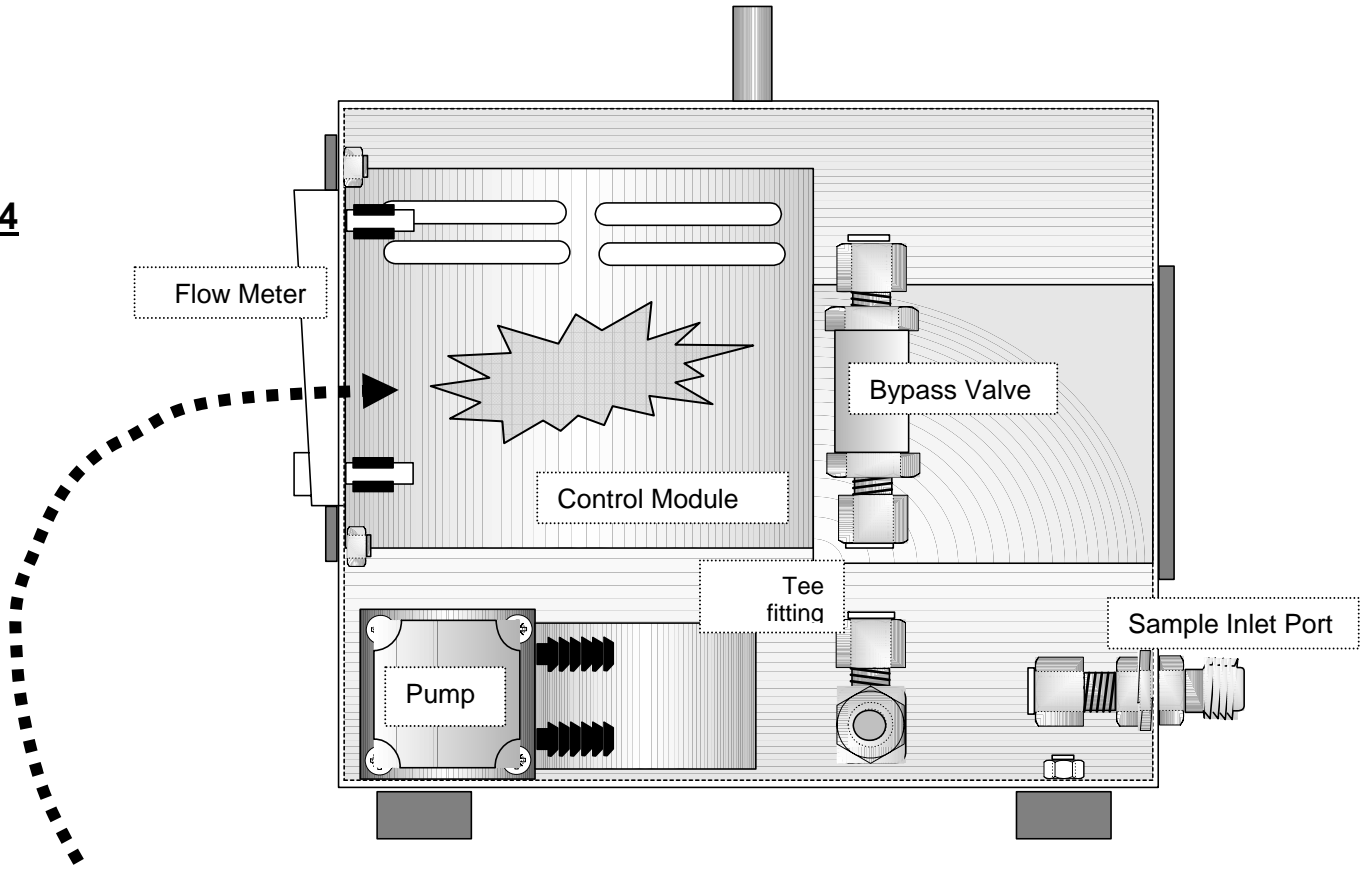
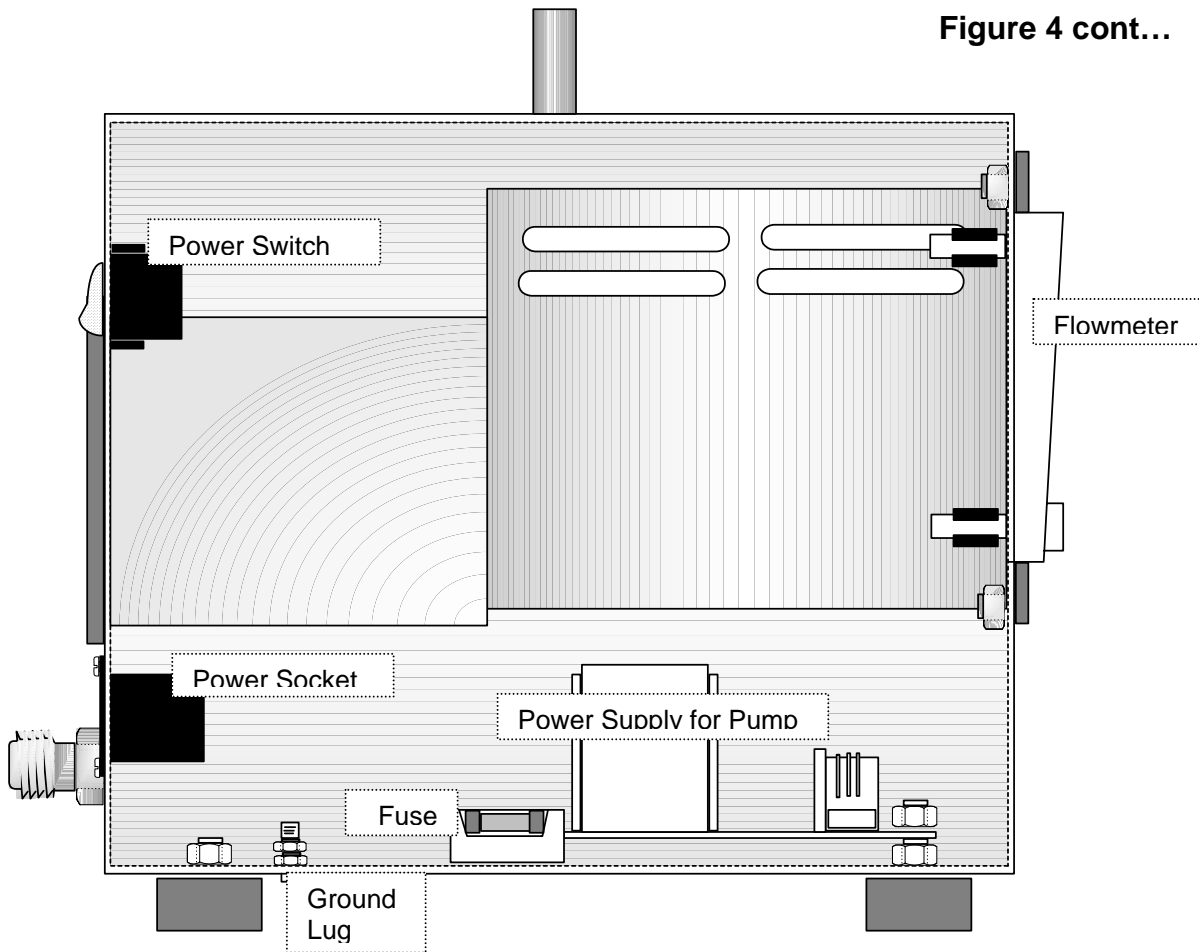

Figure 4 cont...



### 1.3.1 **Main Board**

The microprocessor-based main board controls the operation of the Model 7100P Portable analyzer. The main board receives the sensor signal, amplifies it, and provides the control and display functions of the analyzer.

### 1.3.2 **Relay Board**

The Relay Board provides dry contacts for alarms 1 & 2 plus the Fault alarm. Alarm 1 & 2 are field adjustable setpoints based on the concentration of oxygen. Alarms 1 & 2 may be factory configured as Ascending or Descending trip AND Fail safe or non-Fail Safe. The default settings are ascending and non-Fail Safe for both alarms 1 & 2. Alarms 1 & 2 are 1 Form C (DPDT) relay contacts. The Fault alarm is a 1 Form B (SPST-N/O held closed during normal operation) relay contact which is factory configured as Fail Safe and is used for detection of system errors. System errors include Calibration failure, out of Range, A/D error, and software watchdog.

**1.3.3 Power Supplies:** The controller power supply board is designed to take 90-250 VAC 50/60 Hz. as input. The supply is internally fused directly on the board. A secondary 90-250 VAC 50/60 Hz. power supply is provided to drive the VDC Pump. 7100P Models are available to meet power requirements for use in North America, Asia or Europe.

**1.3.4 Display Board:** The Display board is designed to generate a digital indication of the concentration of oxygen. The Display will also indicate error codes.

**1.3.5 Control Panel:** The Control Panel serves as the main user interface. The Control Panel features the **keypad** (ramp-up, ramp-down, and mode keys) and the **status LEDs**. The control panel is designed to be splash and water resistant. At the four corners of the panel are the #8-32 mounting studs which allow flush mounting of the instrument to a control or equipment panel.

**1.3.6 Sensor:** The Neutronics Inc. *ZR-400 mini Zirconia* sensor for measuring PPM range oxygen is a cost effective solution for many applications. It is a solid state device based on a Zirconia solid electrolyte sensor with a low power, on-board heater. Unlike many solid state oxygen sensors, the ZR-400 does not require a reference gas for normal operation. The sensor operates in a current limiting type configuration. The basic electrical diagram of the sensor is in figure 5:

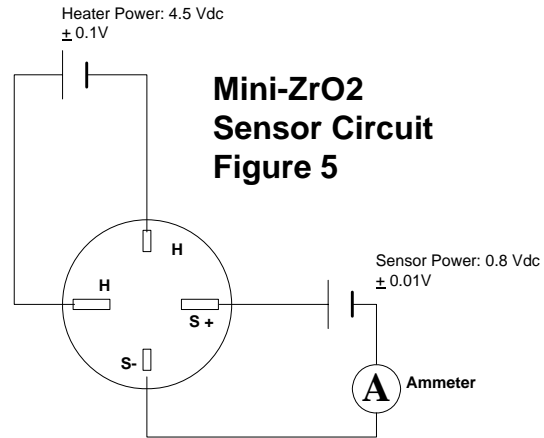

The sensor is an electrochemical cell which measures oxygen. The sensor itself is mounted directly onto a printed circuit board (see figure 6). The circuit board controls sensor excitation voltage and also the heater voltage. Basically, a voltage is applied to the sensor element. Diffusion of oxygen into the sensor is controlled by a small capillary on the sensor surface. At operational temperature, oxygen is electrochemically reduced at the cathode. Oxygen concentration in the sample gas is determined by measuring the current flowing through the S+ and S- terminals of the sensor. The robust design of the sensor assures accurate measurement as well as a quick response characteristic to serve a wide range of oxygen measurement applications. A major advantage of the ZR-400 sensor is that it is not affected by the position. Additionally, there exists no real limitation on shelf life or storage temperature. Sensors may be exposed to severe temperatures and perform to specification once brought up to operating conditions. The sensor may be exposed to several G-Force with no ill effect on performance. Perhaps the most attractive feature of the ZR-400 is its long life. Expected operating life is five years under normal operating conditions!

**Figure 6: Installation of the Mini-Zirconia oxygen sensor on the controller board / Cell Block.**

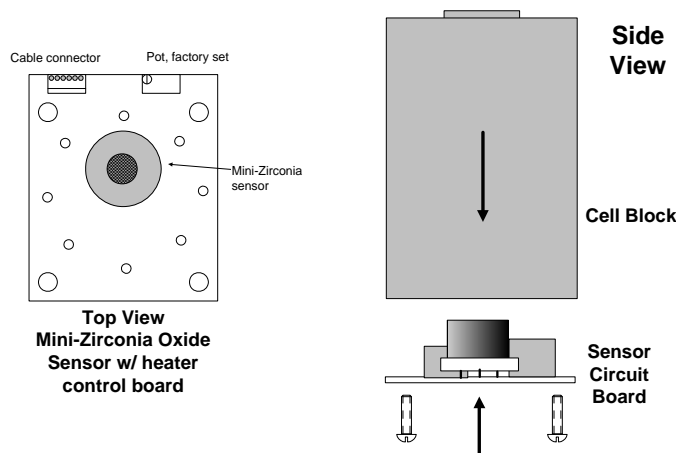

Figure 7: Sensor Cell Block

**1.3.7 Cell Block:** This assembly (for local sensor mounting version) serves as both the receptacle for the sensor as well as the delivery system for the gas sample entering the analyzer. Gas is directed from the sample input port (1/8 inch Female NPT) through a flow restrictor to the face of the oxygen sensor. Oxygen concentration of the gas is determined by the sensor. The gas then passes around the sensor to the sample exhaust port (1/8 inch Female NPT). The sensor controller board retains the sensor and serves as the main mounting mechanism of the sensor to the cell block. The sensor controller board is fastened to the cell block via mounting screws.



The sensor controller board retains the sensor and serves as the main mounting mechanism of the sensor to the cell block. The sensor controller board is fastened to the cell block via mounting screws.

**1.3.8 Chassis:** The chassis is manufactured of specially coated steel. It is designed to provide a general level of protection against mechanical damage from the local environment. It is also an important component of the ESD shielding design.

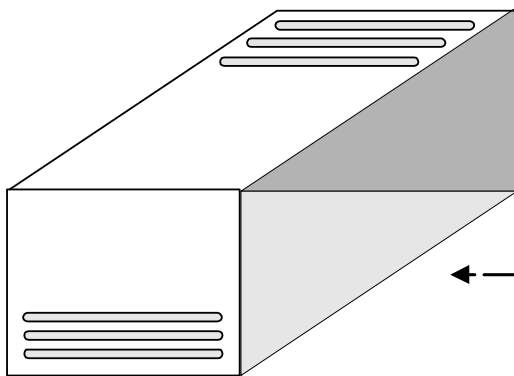

Analyzer  
Electronics  
Package gets  
inserted here

FIGURE 8 Model Chassis

**1.3.9 Pump:** The pump is designed to deliver a gas sample to the sensor. It is a brushless VDC motor drive with plastic pump housing. Neoprene valves and seals ensure gas tight service. Total flow is approx. 1 SLPM. @ STP.

Figure 9 Sample Pump

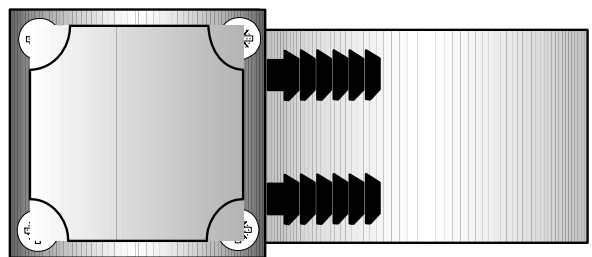

**1.3.10 Bypass Valve:** The Bypass valve creates a constant backpressure ( 5 psig) on the sensor orifice and hence a stable sensor flow. Additionally, the Bypass valve ensures a fast response time by allowing a portion to bypass the sensor and continuously sweep the system of previous gas samples.



Figure 10 Bypass Valve

**1.3.11 Sample Flowmeter:** The sample flowmeter (non-adjustable) indicates the flow through the sensor. Typical flow through the sensor is approximately 0.6 to 1.2 SCFH. Total flow through the analyzer is 1 SLPM.

**1.3.12 Pump Power Supply :** In addition to the power supply located within the controller, a second power supply is mounted within the 7100P chassis. This secondary power supply provides a VDC voltage to operate the pump.

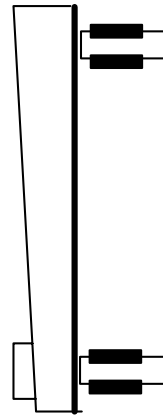

**Figure 11**  
**Sample flow meter**

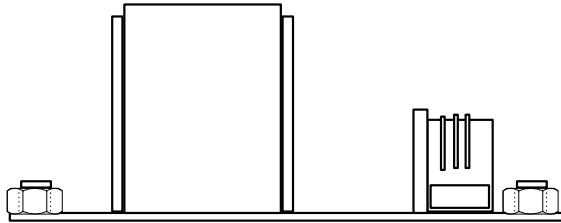

**Figure 12**  
**Pump Power Supply**

# SYSTEM CONFIGURATION

Figure 13

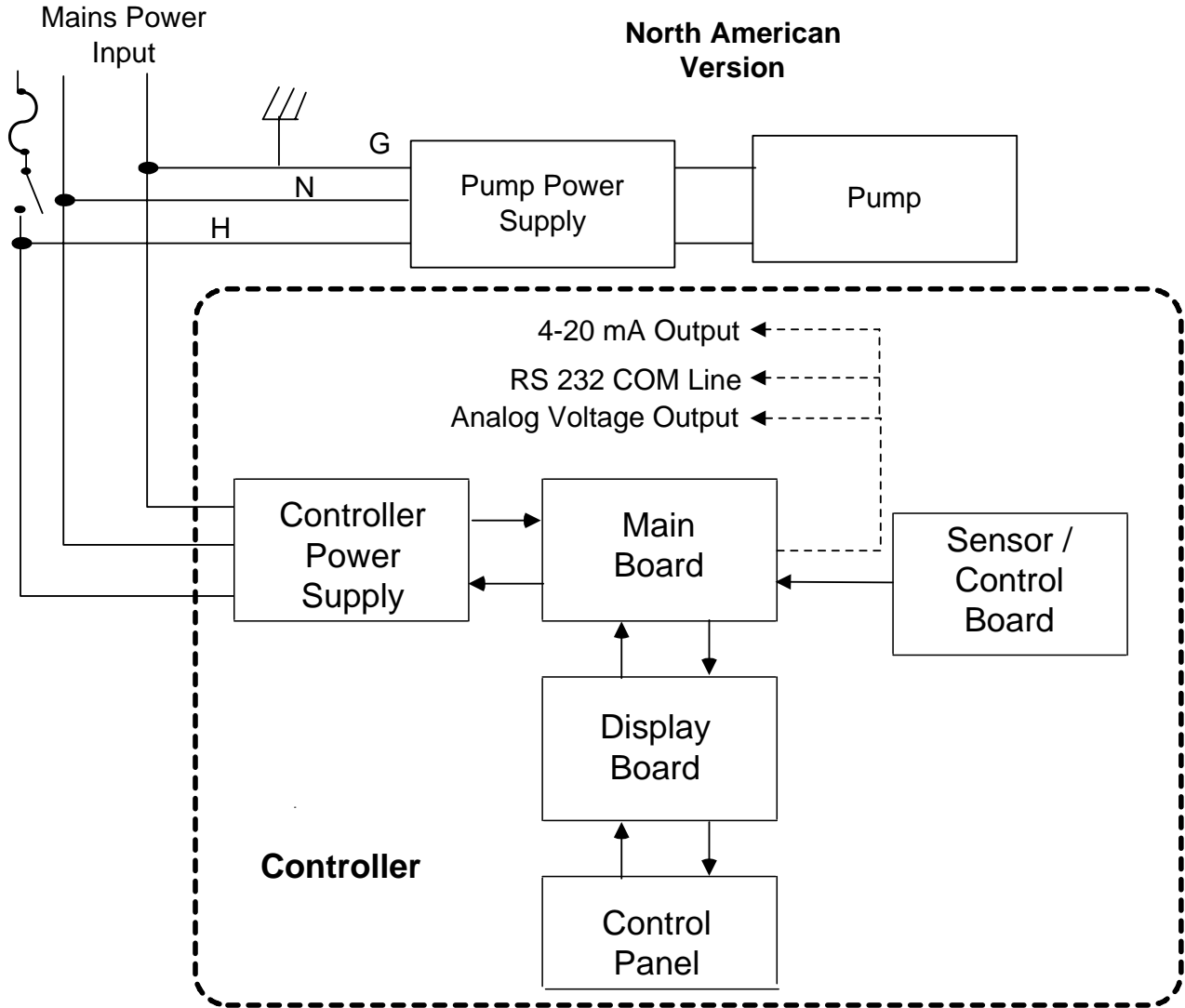

# SYSTEM CONFIGURATION

Figure 14

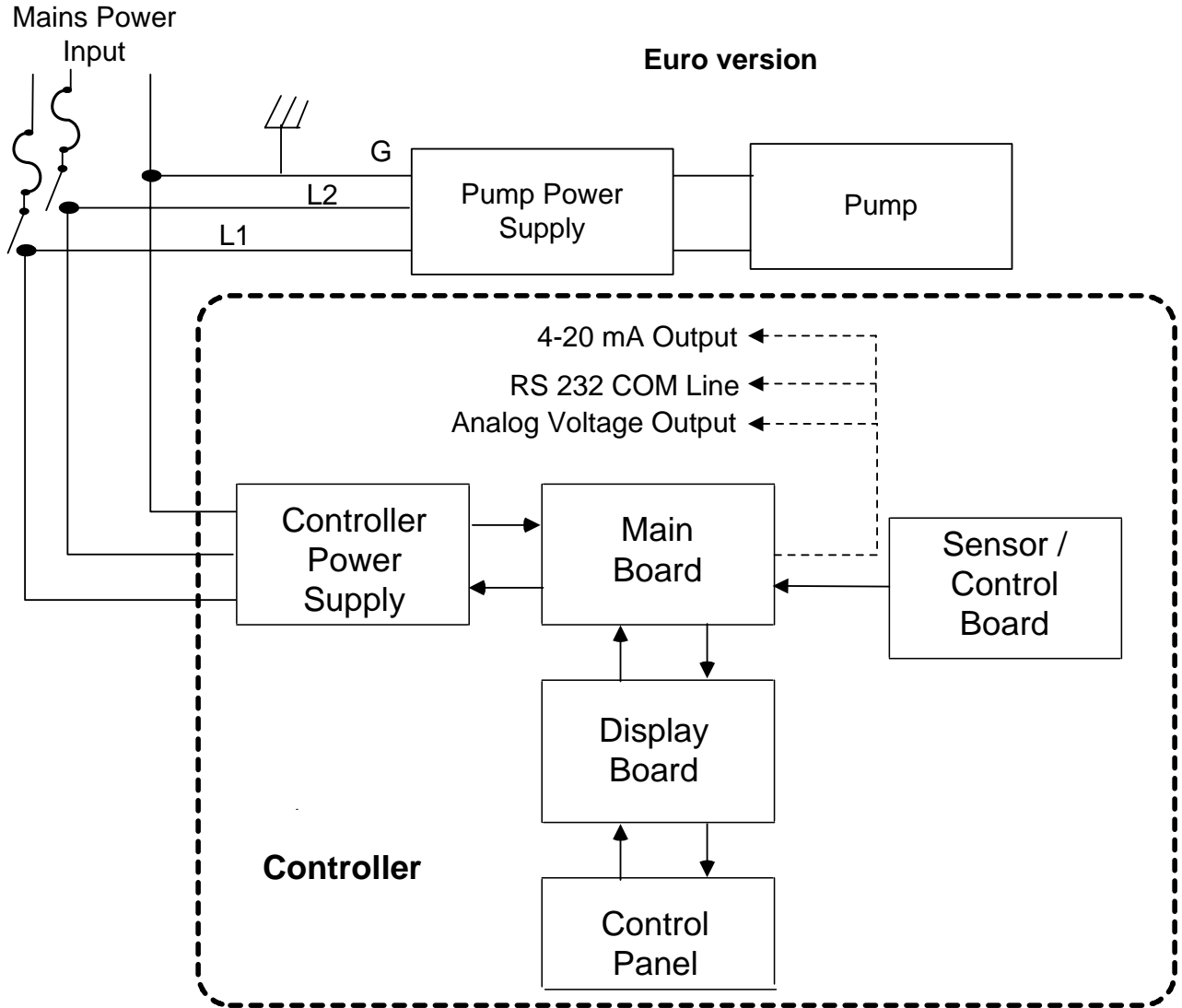

## Commissioning the Model 7100P

### 2.1 Installation

Figure 15

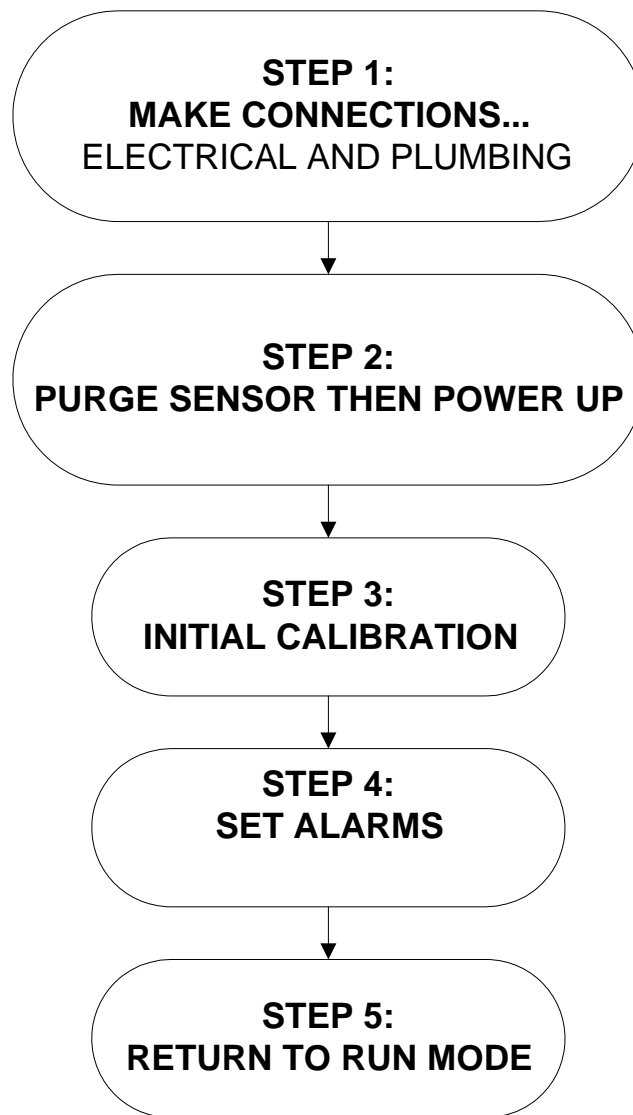



## 2.1.1 STEP 1 MAKE CONNECTIONS:

The Model 7100P Portable analyzer is designed to be portable and used on location for various applications. It is designed for measuring oxygen in pure gases such as nitrogen, argon, helium,... It will not work in aggressive environments such as acid vapors, solvent vapors, or reactant gas environments found in semiconductor wafer manufacture. Some applications may require an additional external filter to remove excess particulates from clogging the sample lines. Likewise, some applications will require the use of an external carbon filter or molecular sieve to prevent aggressive process vapors from attacking or clogging the orifice of the sensor. For example:

- **Solder reflow applications:** Install the optional carbon filter tube assembly to the sample inlet port of the 7100P before measuring the purged zones. The heating of circuit boards in Solder reflow machines may cause the formation of resin vapors, which may eventually plug the sample tubing and sensor if not filtered. If the sensor has been plugged with solder reflow residues, it must be replaced. It is impossible to clean a clogged sensor so be sure to install an external filter.

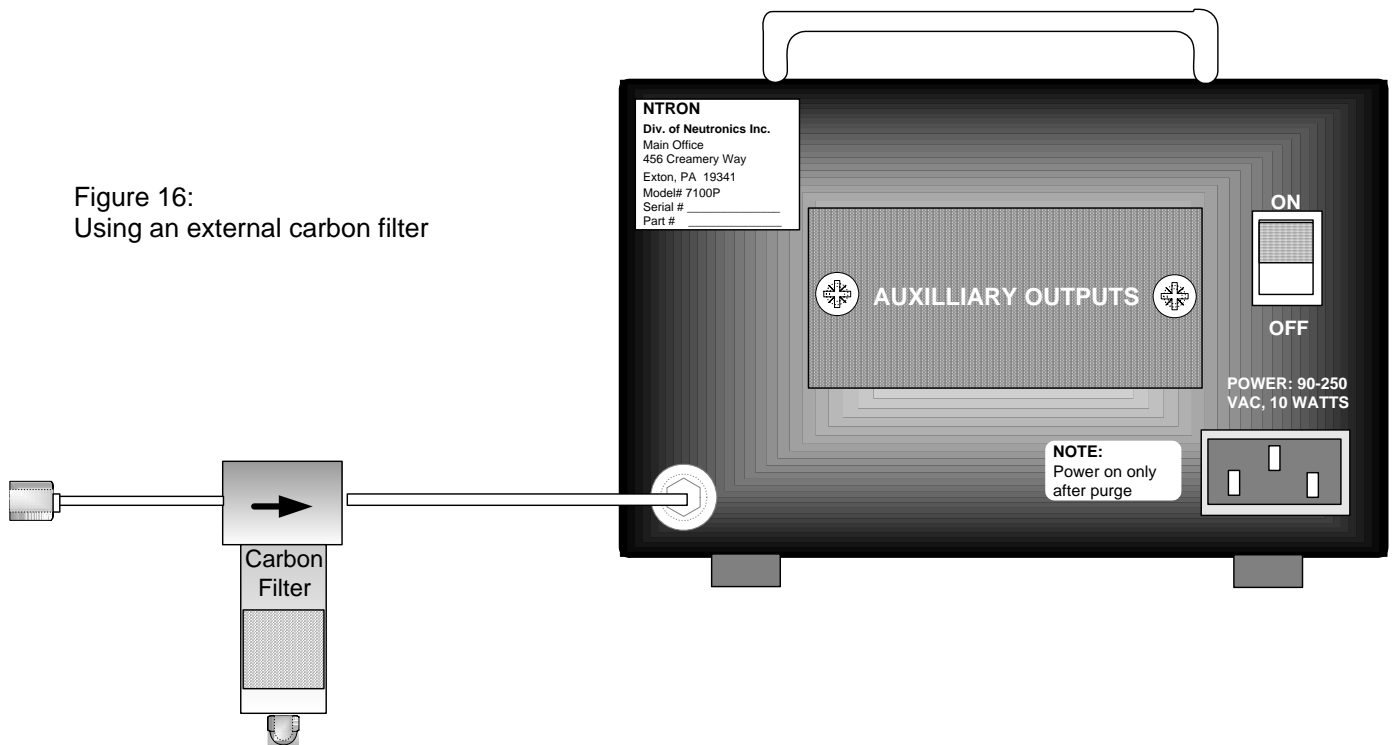
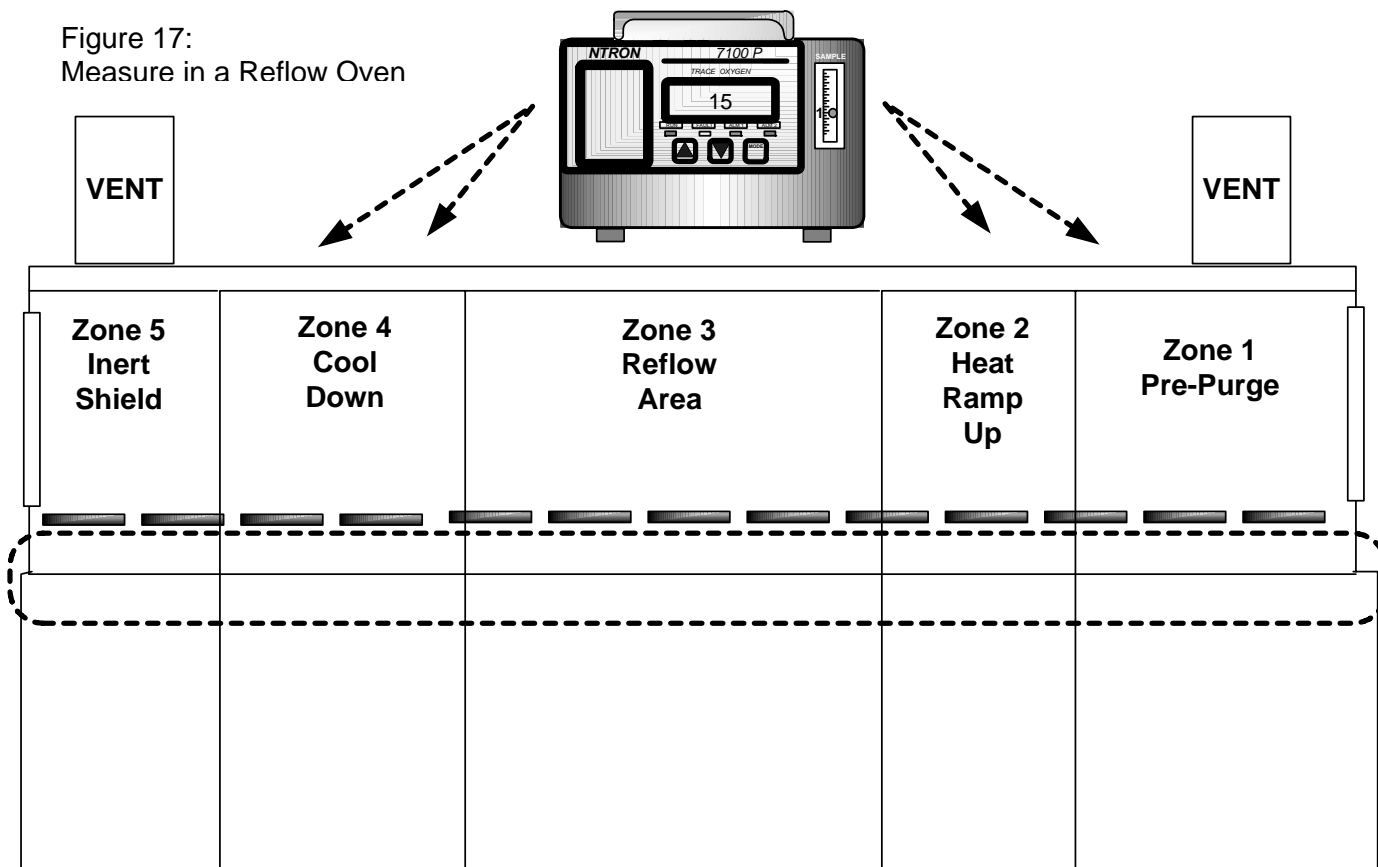

Figure 16:  
Using an external carbon filter

Figure 17:  
Measure in a Reflow Oven



- ❑ **Metal, ceramic, wire annealing:** In general, these processes use very clean atmospheres. However, there may be the need to filter excess particulates from the sample gas that could block sample tubes or sampling components. An internal sintered metal filter is mounted within the 7100p to catch particulates from damaging the sensor. However, this sensor is used as a last resort and external filtering is generally required. Install the optional particulate filter on the sample tube as it enters the 7100P. The 7100P is not rated intrinsically safe and is not suitable for measuring annealing atmospheres containing hydrogen or hydrocarbons. These gases are flammable and could ignite in the heated sensor.

Figure 18:  
Using the External  
Sintered Metal Filter

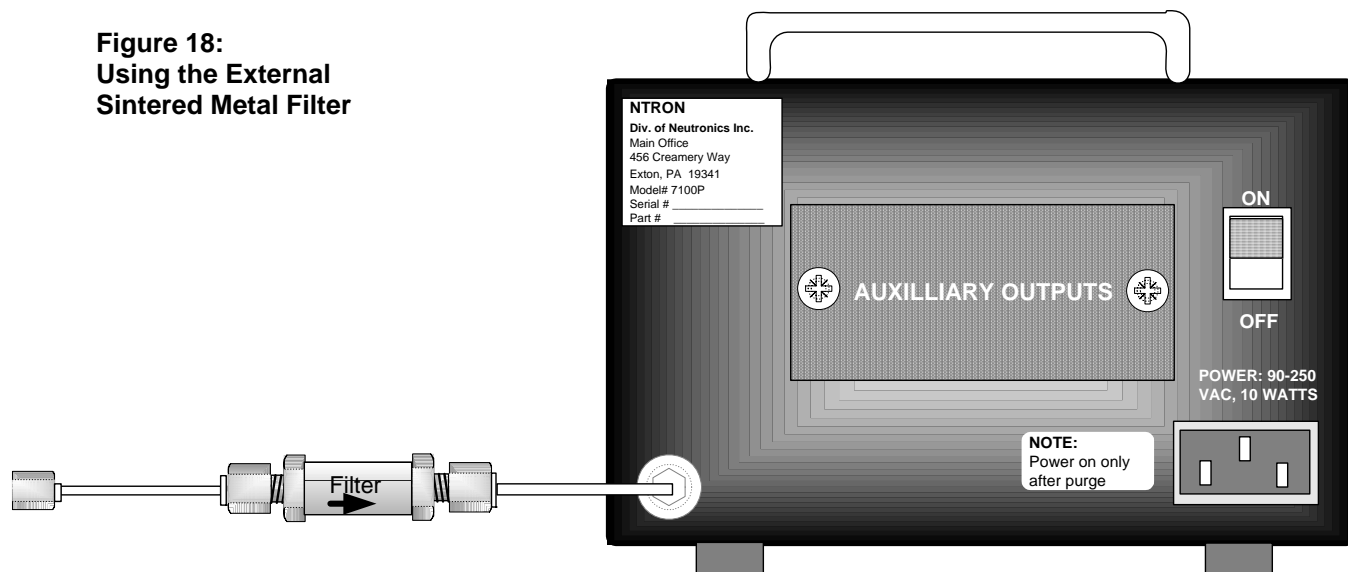

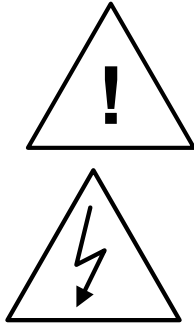

**CAUTION:** The Model 7100P Portable analyzer features a heated mini-Zirconia sensor. Do not attempt to access the sensor or sensor control board until power has been removed from the unit and you have allowed sufficient time for the heater to cool down, about 5 minutes.

**DANGER:** Electrical connections on the rear of the Model 7100P Portable analyzer may have hazardous voltages present once power has been applied to the unit. High voltages may be still remain for a short time even after power has been disconnected from the analyzer. Take care in observing standard electrical practices when making electrical connections to the Model 7100P Portable analyzer.

**DANGER:** The model 7100P Portable analyzer is not rated intrinsically safe or explosion proof. Be certain that all flammable and toxic gases are not present in the area where the Model 7100P Portable analyzer will be installed.

**CAUTION:** The model 7100P Portable analyzer housing is not rated waterproof. Do not mount the analyzer or the sensor in an area where it may contact water or other liquid elements.

- **High Purity Welding [checking the shield gas]:** When high purity welds are made, a shielding gas of nitrogen or argon is used to purge oxygen out of the tubes or pipes to be welded together. To ensure the oxygen has been effectively purged out, the use of the 7100P oxygen analyzer can be easily used. Install the external sintered metal Prefilter to make sure no particulates [metal filings...] enter the sample line. Additionally, to speed up the purging of the tubes to be welded, the use of a 3 way high flow bypass valve can be used. See figure 19.

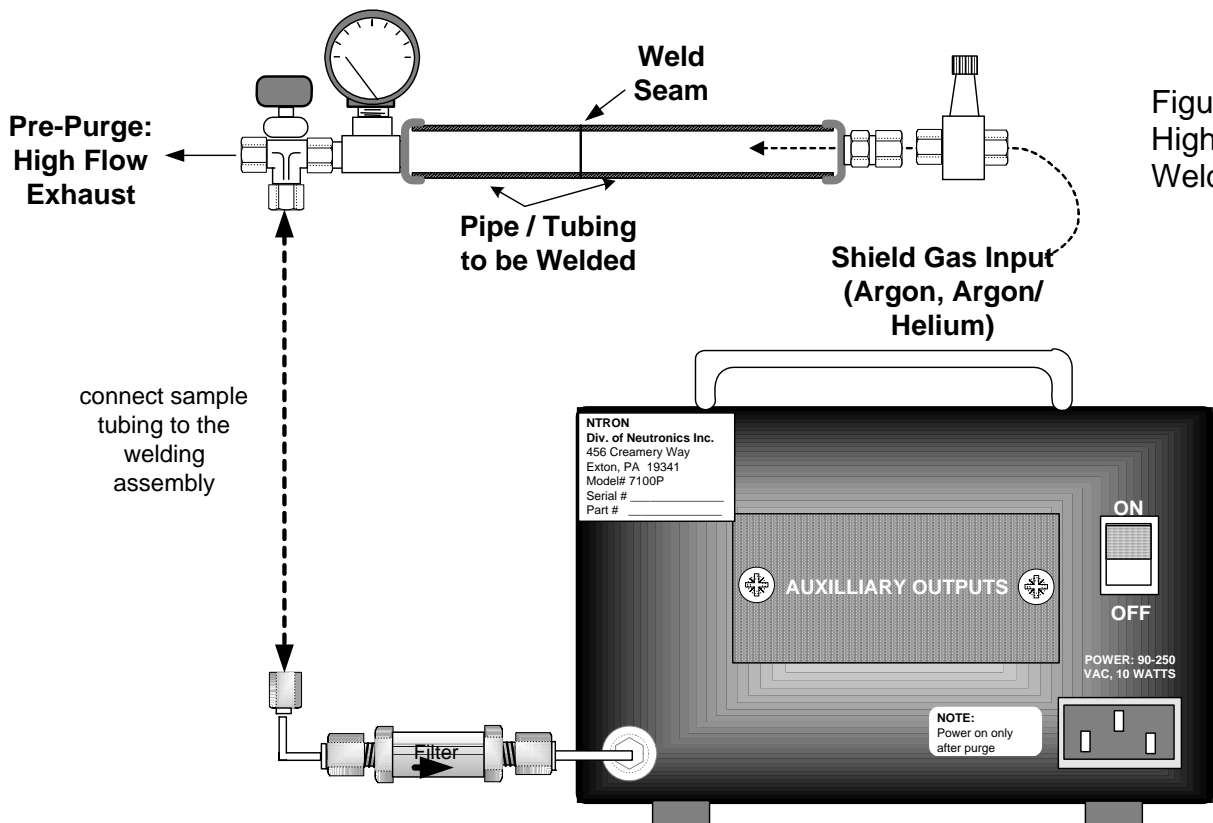

Figure 19  
High Purity  
Welding

For welding exotic metals [titanium, hastelloy,...] it may be desirable to monitor and control the pressure of the shield gas within the tubing to be welded. This is because you can control the shape of the weld bead as it is formed during the welding process. It is usually beneficial to force the bead to shape towards the outside diameter of the weld seam. See figures 20 and 21. This will result in a smooth interior finish of the inside diameter of the welded joint.

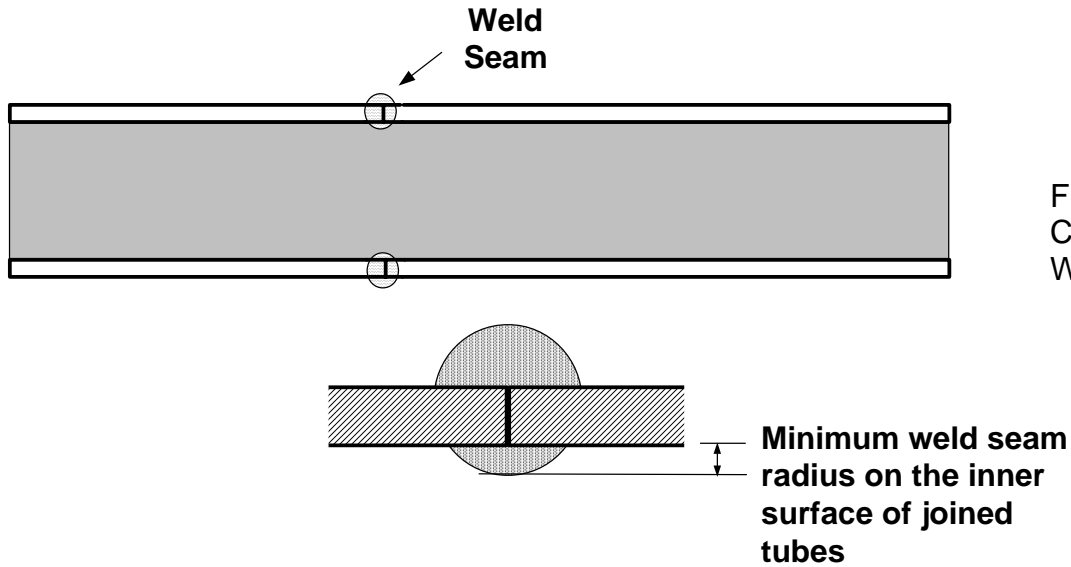

Figure 20  
Control the  
Weld Bead

- Deluxe Shield Gas Kit Includes (Model DSG):**
- 316 SS Glycerin Filled Pressure Gage for Low Positive Pressure
  - 316 SS Ballvalve manifold assembly
  - 316 SS Pressure Regulator for Shield Gas Input (1/4 Female NPT)

- Econo Shield Gas Purge Kit Includes (Model ESG):**
- Steel Pressure Gage for Low Positive Pressure
  - 316 SS Ballvalve manifold assembly
  - Aluminum Pressure Regulator for Shield Gas Input (1/4 Female NPT)

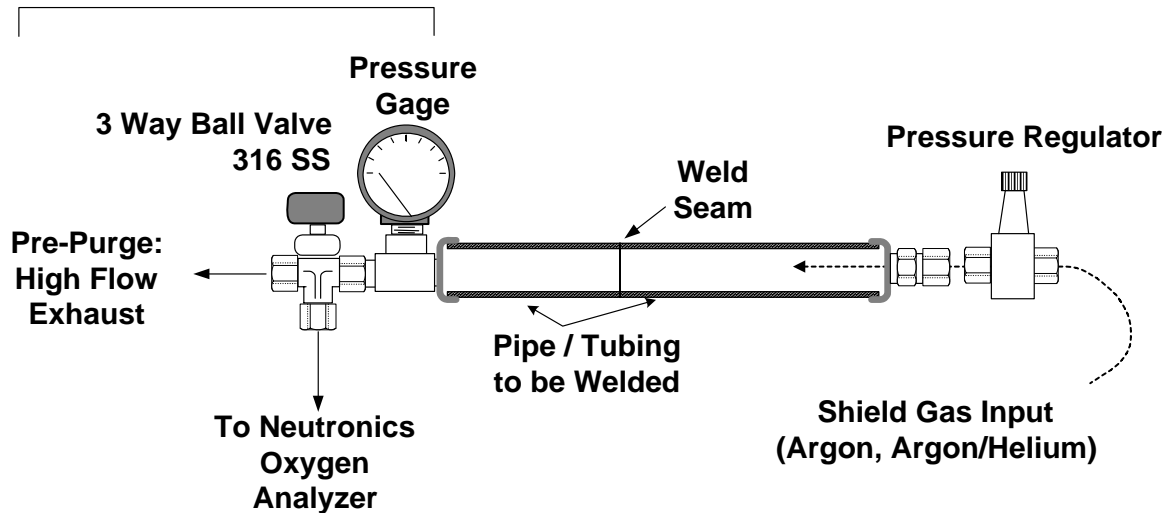

Figure 21  
Welding  
Accessories  
for the 7100P

Some welders use a purge dam to reduce the overall consumption of shield gas. The dam forces the purge gas to enter a confined area around the seam to be welded. Dams are available for various size tubes and feature quick connect fittings for easy coupling to the shield gas source. To position the dam around the seam, a chain or rope is connected at either end of the dam, and the assembly is pulled through the tube until in place. The dam features soft elastomer gasketing to ensure a gas tight seal. See figure 22. Purge dams are available from Neutronics. Contact our Applications department for more information.

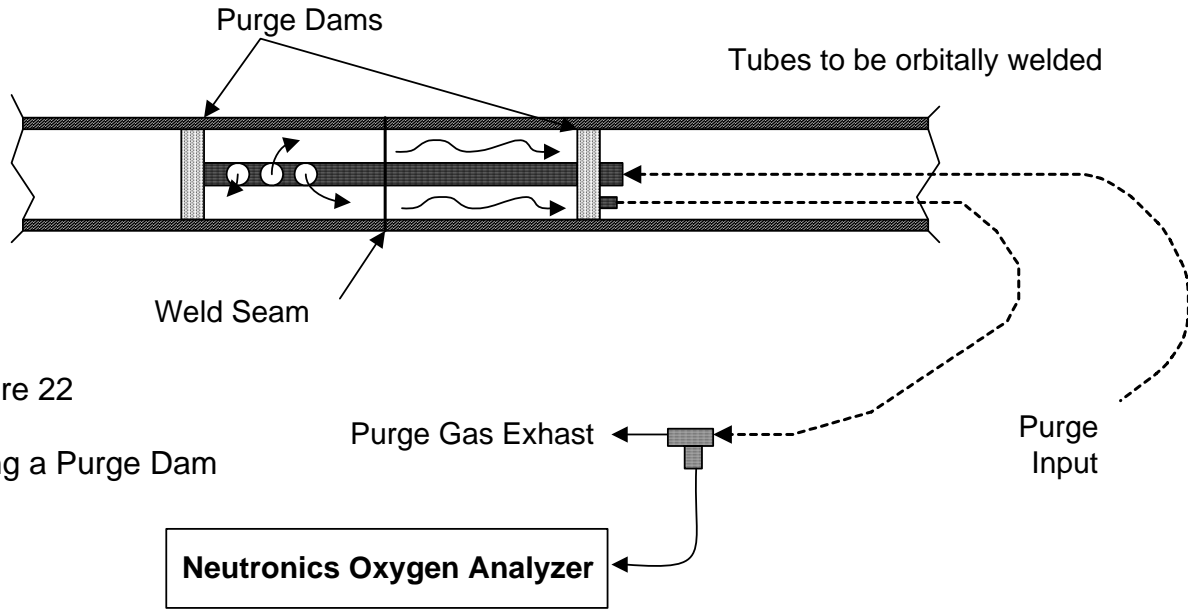
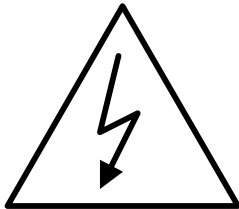

Figure 22

Using a Purge Dam

**2.1.2.1 Install the Plumbing:** Plumbing connections for the standard Model 7100P Portable analyzer are made at the back of the chassis at the sample tube. Choose the right prefiltering required for your application and install the sample tube and accessories as shown in the figures above. Do not overtighten fittings. The threads of the fittings should be wrapped with Teflon tape to prevent gas leakage. For best results, make sure the sample pressure is regulated so that you have approximately 0.8 to 1 SCFH flow rate as indicated on the flow meter.. Do not exceed 5 psig at the sample input port. To prevent back pressure on the sensor, the sample exhaust should be vented to atmospheric pressure.

**2.1.2.2 Electrical Connections:** When Using the 7100P as a monitor only, you need only connect the power input cord into the power socket and turn the unit on [after a 5 second purge]. It is possible to record the data via the RS-232 serial port, 4-20 mA analog output, or the analog voltage output. The 7100P features 2 alarms that can be set to specific gas concentration set points. Local LEDs signify the alarm status. If you have the optional relay outputs, you can preset alarm levels and interface to dry relay contacts. The serial, analog, and optional alarm outputs are available at terminal blocks located behind the rear access panel. Simply remove the plastic panel to gain access to the pluggable terminal blocks. A label depicting the terminal block arrangement is affixed to the back of the access panel for easy reference during installation and maintenance. The terminal blocks feature screwed terminals. The terminal blocks are removable for ease of wiring or removal of the analyzer module. Please reference the attached sketch showing the detail of the electrical interface terminals.



**WARNING:** Be certain that all power is OFF to the analyzer and associated wiring (cables) before attempting installation. **DO NOT WORK WITH LIVE WIRES!** Do not leave any exposed wire at the terminal blocks. Before applying power, ensure terminal blocks are fully inserted into the mating connector at the analyzer.

To remotely detect the present range of oxygen concentration, the Model 7100P Portable analyzer features a optional 0-10 volt **auto-range identification output** which is available if you purchased the Alarm Relay Option. See Table below under the “Range Voltage Output” heading.

**Figure 23 Range Description Table**

Display range Setting (internal to software)	Range Name	Measurement Range	Display	Analog Range	Range Voltage Output ( $\pm 0.01$ vdc)
1	Fixed 0-10 ppm Range	$0 \leq x \leq 9.9$ PPM	X.X	0...10PPM	3.13 Vdc
2	Fixed 0-100 ppm Range	$0 \leq x \leq 99$ PPM	XX.X	0...100 PPM	3.75 Vdc
3	Fixed 0-2000 ppm Range	$0 \leq x \leq 2000$ PPM	XXXX.X	0...2000 PPM	4.38 Vdc
8	Auto Range	$0 \leq x \leq 2000$ PPM	XX.X-XXXX.X	0-9.9 10.0 –99.9 100-1999.9 PPM	3.13 Vdc 3.75 Vdc 4.38 Vdc

**FIGURE 24**  
**REAR OF CHASSIS: ELECTRICAL and PLUMBING CONNECTIONS**

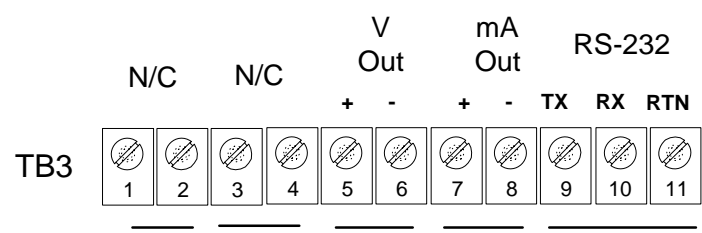
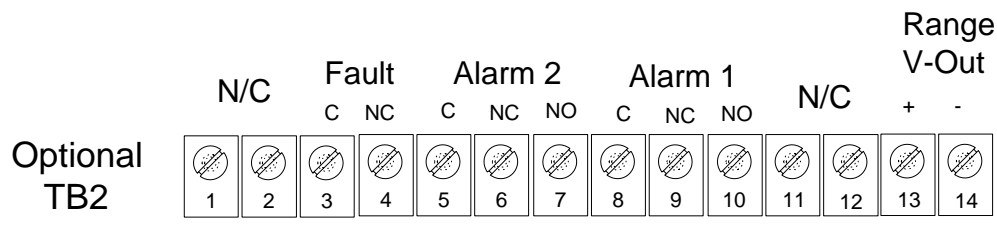
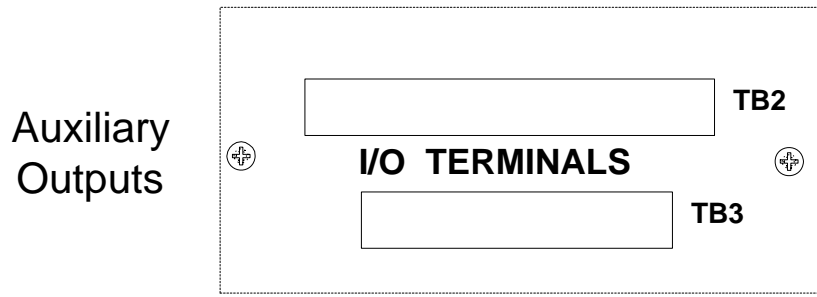
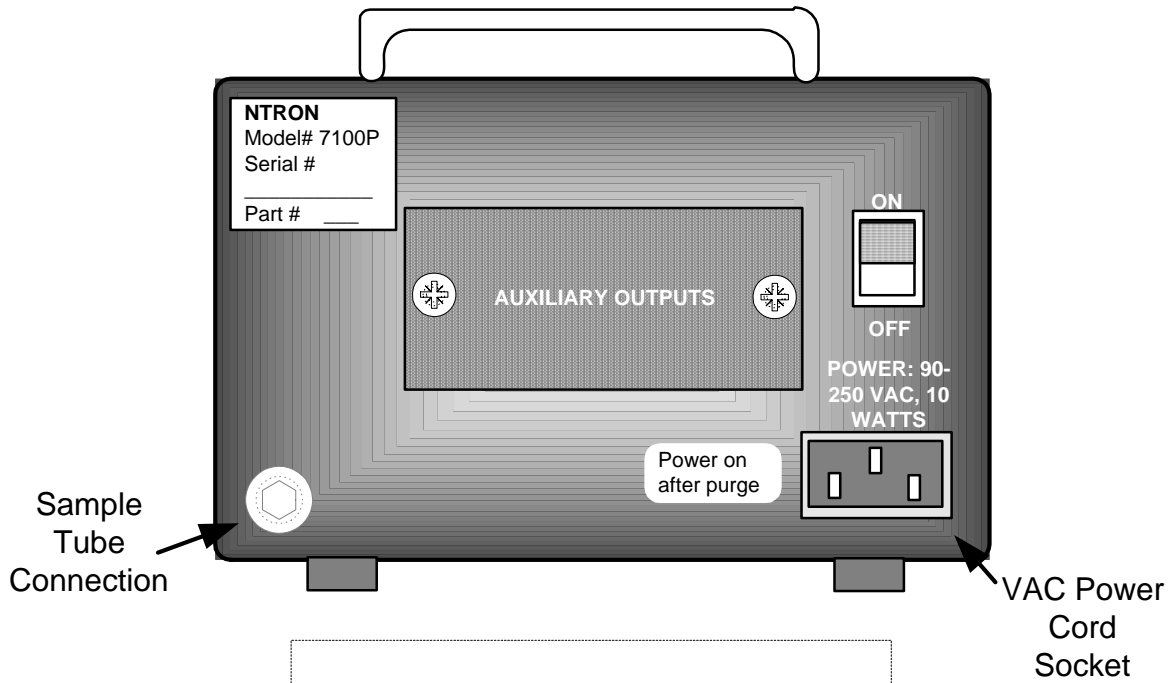

## 2.2 Start-up

### 2.2.1 Last Check Before Power Up:

Check List ? .....

- √ Are you using the analyzer in an area where there are no flammable vapors?
- √ Avoid exposing the analyzer to rain, dripping water, or hose down?
- √ Installed the power cord and optional wiring?
- √ Ensured gas tight plumbing and external filter installation?
- √ Regulated the sample pressure as instructed?
- √ Read the manual in its entirety?
- √ Flow PPM gas to unit before power up?

**YES... then apply power to the unit.**

### 2.2.2 STEP 3 Power Up the unit:

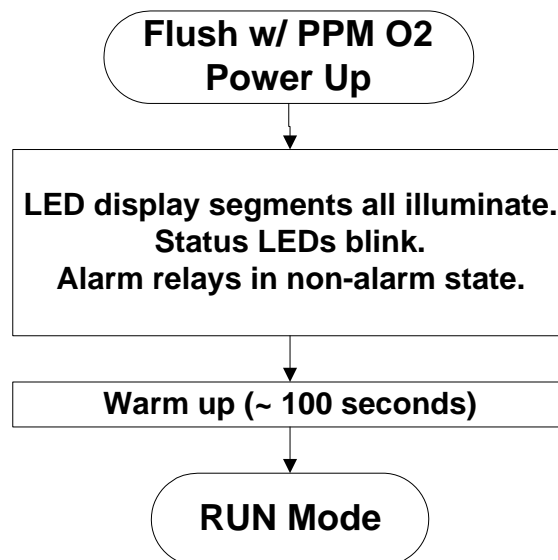

FIGURE 25 POWER UP DIAGRAM



**NOTE:** Before powering up the model 7100, it is important to purge the sensor of ambient air. This will facilitate a quick initial response to ppm levels of oxygen. The sensor used in the model 7100P Portable analyzer is designed for use in PPM concentrations of oxygen. If the analyzer is powered up while the sensor is exposed to ambient air, then the sensor will saturate with oxygen and may require up to 5 minutes recovery time once exposed to trace oxygen gases. To prevent this delay due to saturation, **you should flow ppm level oxygen (or zero gas) to the sensor before power up.**

It takes approximately 60 seconds to sweep the sensor out when zero gas is swept through the analyzer. Then you can apply power to the analyzer. Exposure to air does not affect the life of the sensor. Exposure to air while the unit is on will slow response.



When the instrument is connected to power and turned on, the Model 7100P Portable analyzer will go into a self test mode. The digital display will show "8888" and the decimal point will scroll. The LEDs will flash. After approximately 8 seconds, the analyzer will display the software version number and then it will enable the warm-up of the instrument. The warm up takes about 100 seconds. The digital display will alternate between reading "nr" for not ready and indicating the number of seconds remaining (count down) before warm-up is complete. After the warm up period is completed, the model 7100P Portable analyzer will check its current reading and update the digital display and status LEDs. Though the unit can be immediately used after warm up, best stabilization of the sensor signal may be obtained after the instrument has been on for approximately 5 minutes. This will allow the sensor to stabilize and adjust to the ambient temperature.

Once the analyzer has stabilized (3 minutes), apply 1-3 psig cal gas to the sample input port of the analyzer. Allow the reading to stabilize (about 60 seconds for the gas to sweep out the sample lines) and then calibrate the unit.

### 2.2.3 STEP 4 Two Point Calibration:

***NOTE: DO NOT CALIBRATE WITH A ZERO GAS. SETTING ZERO WILL CREATE ERROR IN THE MEASUREMENT CALCULATIONS!***

The model 7100P Portable analyzer has been factory calibrated using two calibration gases and verified at several other points within the range of the unit. The factory calibrations and verifications were made using gases with a background of Nitrogen. The model 7100P Portable analyzer is ready for use upon removal from its shipping carton and does not have to be calibrated .



**NOTE:** It is recommended to calibrate the model 7100P Portable analyzer at regular intervals of at least once every six months. You can calibrate using a single calibration gas however, a two point calibration will attain the highest degree of accuracy. Additionally, to attain the highest degree of accuracy, the model 7100P Portable analyzer should be recalibrated for use in other background gases such as Argon or Helium. In this case, purchase a calibration gas with PPM oxygen in the appropriate background gas. Calibration gases are available from many specialty gas manufacturers. You may contact the Neutronics Application Department in finding a specialty gas distributor in your area. A two point calibration with the appropriate background gas will provide the highest degree of accuracy. Calibration gas should be regulated to 1-3 psig at a controlled flow (1 scfm) before entering the sensor. For single point calibrations, select a calibration gas with an oxygen concentration in the range of 10 to 50 ppm. For a two point calibration, the second calibration gas should be in the range of 500 to 750 ppm oxygen.

#### **Single point Calibration:**

After the calibration gas (10-50 ppm O<sub>2</sub>) has been applied to the analyzer and the display has stabilized, press the "MODE" button. It will display "CAL" while depressed. The Green RUN

LED will flash. After releasing the button, the display will indicate an oxygen concentration value. Adjust the digital display to read the correct concentration of oxygen by pressing the UP or Down arrows as required. Press the “MODE” button again to scroll past the “ALM1” , “ALM2”, and Fault Modes as indicated on the display.

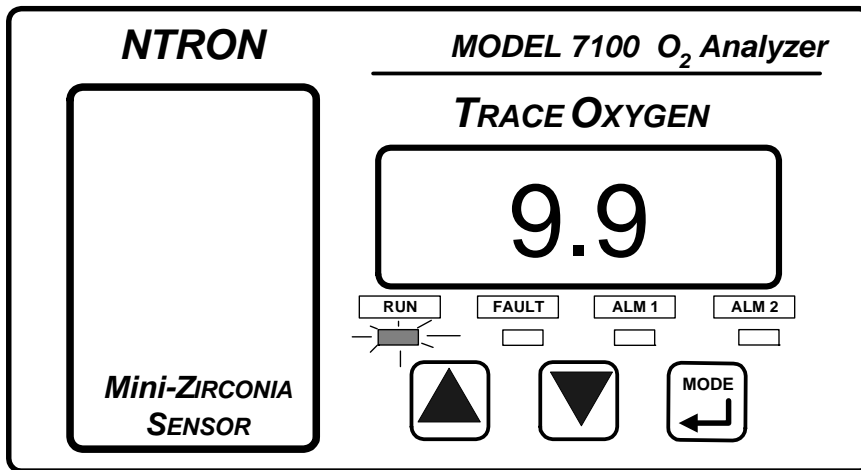

Figure 26 Cal Mode: A look at the Display Panel

The Model 7100P Portable analyzer will resume normal RUN mode operation when the UP, DOWN, or MODE buttons have not be pressed within a 120 seconds period.

#### For Two Point Calibration:

After the second calibration gas (500 to 750 ppm O<sub>2</sub>) has been applied to the analyzer and the display has stabilized, press the “MODE” button. It will display “CAL” while depressed. The Green RUN LED will flash. After releasing the button, the display will indicate an oxygen concentration value. Adjust the digital display to read the correct concentration of oxygen by pressing the UP or Down arrows as required.

Press the “MODE” button again to scroll past the “ALM1” , “ALM2”, and Fault Modes as indicated on the display.

#### 2.2.4 STEP 5 Set the Alarms:

After the unit has been calibrated on a known gas source, it is desirable to set the alarm points. Scroll through the menu by pressing the “MODE” button until “ALM1” is displayed. Adjust the up and down buttons accordingly. Then, press the “MODE” button again to scroll to “ALM2”. Adjust the display as required. **See Chapter 3 under “Set Alarms”.**

**Notes: The alarms may be configured as Ascending or Descending Trip AND Fail-Safe or Non-Fail-safe. See chapter 3 for a description of the settings and the appendix to find out how to change the factory settings.**

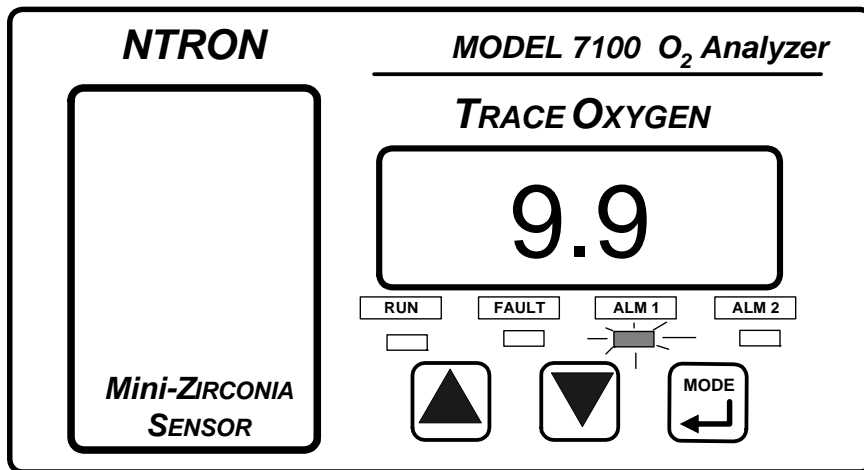

The alarms will become active approximately 120 seconds after exiting the calibration mode.

FIGURE 27 SET ALARM MODE: A look at the Display Panel

### 2.2.5 STEP 6 Return to RUN mode:

After setting the alarms, press the MODE button to scroll past the FAULT (FLT) mode to return to normal RUN mode. A time-out is built in to the unit. After approximately 120 seconds (factory default), if no buttons are pressed, the unit will return to normal RUN mode. See Chapter 3 under "RUN Mode".

# CHAPTER 3

## Modes of Operation

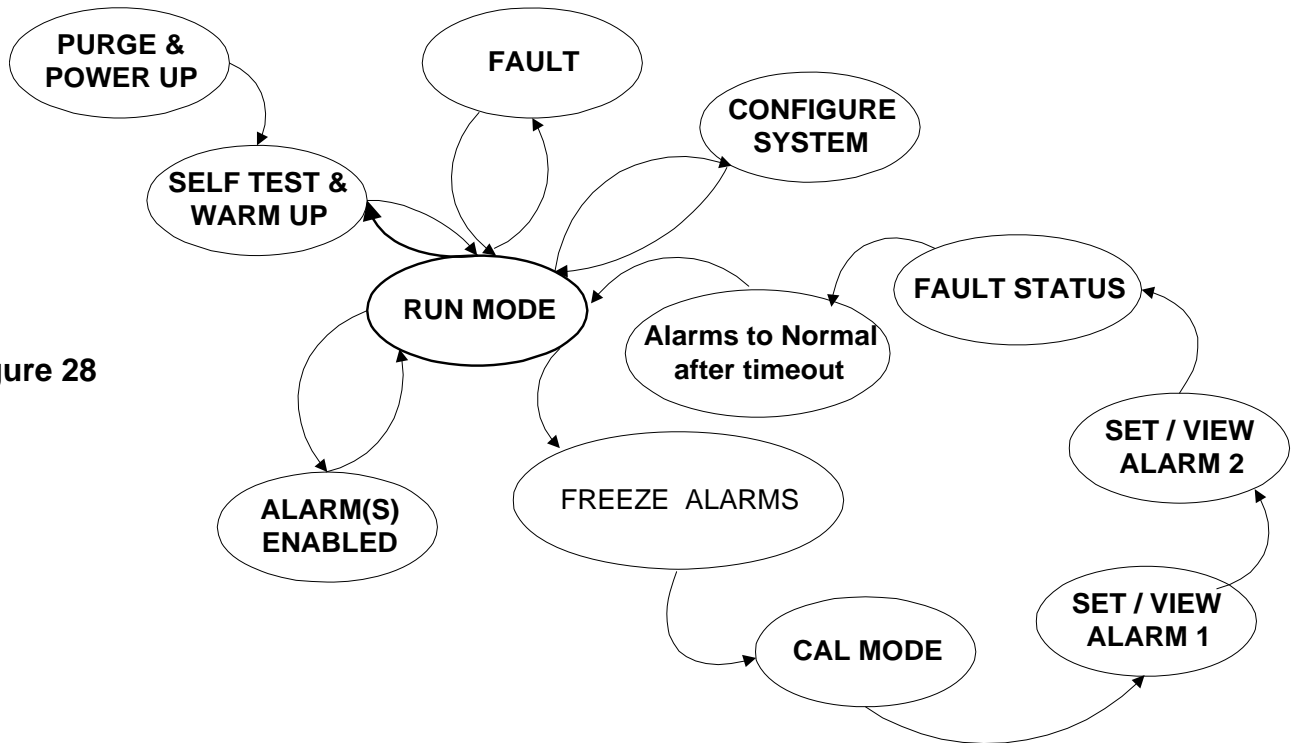

Figure 28

After the unit has been calibrated on a known gas source, it can be used in normal operation. There are six main modes of operation once the system has been powered up and the self test/warm up period is completed: **RUN, Calibration, Set Alarms, Alarms Active, Fault, and SELF-TEST.**

As shown in Figure 28, the modes of operation are accessible once in RUN mode. You can access the Cal or Set alarm modes by pressing the mode switch. CAL and Set Alarm 1 & Set Alarm 2 are sequentially accessed. Alarms active and Fault modes are not accessible manually. The Model 7100P Portable analyzer will determine if an alarm or fault is active, and then the modes will be activated.

The analyzer has a 2 minute time-out (factory default). If no buttons are pressed within 2 minutes, the analyzer will resume to normal RUN mode operation.

The alarm outputs are “frozen” during calibration and alarm set modes... the alarm conditions just prior to entering the cal/set alarm mode are held until returning back to RUN mode.

## A description of each mode:

### 3.1 RUN

Normal RUN mode is indicated by a green LED. The instrument is measuring the concentration of the sample gas and updating the display and outputs accordingly.

**NOTE: The display will flash**

**(bright to dim) when out of range and then go to solid display when in range.**

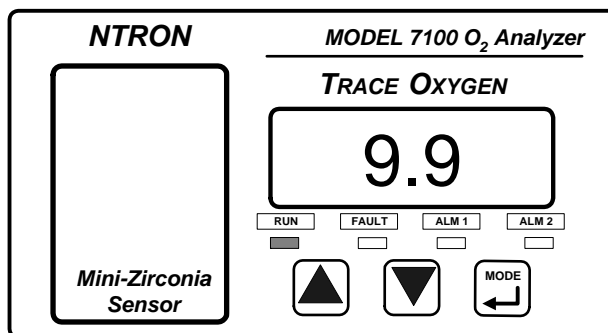

### 3.2 CALIBRATION

Calibration mode allows the oxygen sensor to be tuned to a gas of known oxygen concentration. Flow gas, then enter the cal mode by pressing the mode button once.

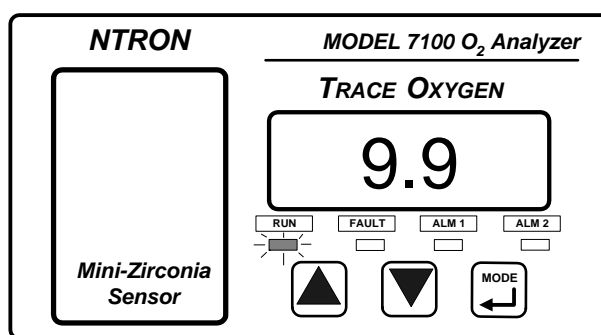

**NOTE: DO NOT CALIBRATE WITH A ZERO GAS. SETTING ZERO WILL CREATE ERROR IN THE MEASUREMENT CALCULATIONS!**

#### When to Calibrate?



- Whenever the sensor board is replaced.
- At least once every 6 months.
- Whenever a FAULT condition is encountered.
- After POWER UP for the first time (wait 5 minutes to stabilize)
- Whenever you are unsure about a oxygen concentration reading.
- When you are switching Background Gases

#### How to calibrate the Model 7100P Portable analyzer ....



**NOTE: Before powering up the model 7100, it is important to purge the sensor of ambient air. This will facilitate a quick initial response to ppm levels of oxygen.** The sensor used in the model 7100P Portable analyzer is designed for use in PPM concentrations of oxygen. If the analyzer is powered up while the sensor is exposed to ambient air, then the sensor will saturate with oxygen and may require up to 5 minutes recovery time once exposed to trace oxygen gases. To prevent this delay due

to saturation, ***you should flow ppm level oxygen (or zero gas) to the sensor before power up.***

It takes approximately 5 seconds to sweep the sensor out when zero gas is swept through the analyzer. Then you can apply power to the analyzer. Exposure to air does not affect the life of the sensor.

### **3.2.1 Two Point Calibration Design :**

The model 7100P Portable analyzer has been factory calibrated using two calibration gases and verified at several other points within the range of the unit. The factory calibrations and verifications were made using gases with a background of Nitrogen. The model 7100P Portable analyzer is ready for use upon removal from its shipping carton and does not have to be calibrated (for Nitrogen background gases).



**NOTE:** It is recommended to calibrate the model 7100P Portable analyzer at regular intervals of at least once every six months. You can calibrate using a single calibration gas however, a two point calibration will attain the highest degree of accuracy. Additionally, to attain the highest degree of accuracy, the model 7100P Portable analyzer should be recalibrated for use in other background gases such as Argon or Helium. In this case, purchase a calibration gas with PPM oxygen in the appropriate background gas. Calibration gases are available from many specialty gas manufacturers. You may contact the Neutronics Application Department in finding a specialty gas distributor in your area. A two point calibration with the appropriate background gas will provide the highest degree of accuracy. Calibration gas should be regulated to 1-3 psig at a controlled flow (1 scfm) before entering the sensor. For single point calibrations, select a calibration gas with an oxygen concentration in the range of 10 to 50 ppm. For a two point calibration, the second calibration gas should be in the range of 500 to 1000 ppm oxygen.

#### **Single point Calibration:**

After the calibration gas (10-50 ppm O<sub>2</sub>) has been applied to the analyzer and the display has stabilized, press the "MODE" button. It will display "CAL" while depressed. The Green RUN LED will flash. After releasing the button, the display will indicate an oxygen concentration value. Adjust the digital display to read the correct concentration of oxygen by pressing the UP or Down arrows as required. Press the "MODE" button again to scroll past the "ALM1", "ALM2", and Fault Modes as indicated on the display.

***NOTE: DO NOT CALIBRATE WITH A ZERO GAS. SETTING ZERO WILL CREATE ERROR IN THE MEASUREMENT CALCULATIONS!***

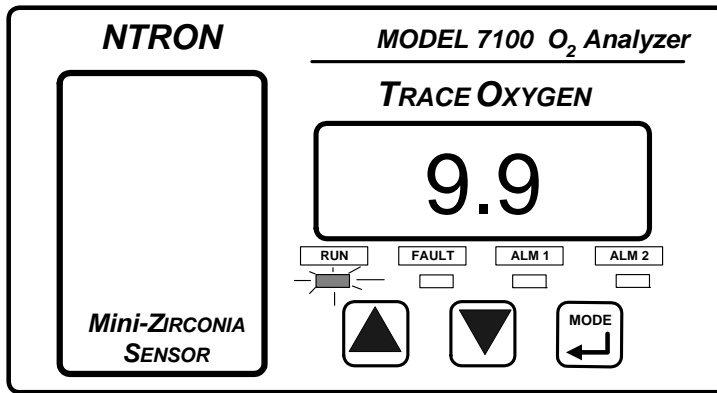

The Model 7100P Portable analyzer will resume normal RUN mode operation when the UP, DOWN, or MODE buttons have not be pressed within a 120 seconds period.

**For Two Point Calibration:**

After the second calibration gas (500 to 1000 ppm O<sub>2</sub>) has been applied to the analyzer and the display has stabilized, press the “MODE” button. It will display “CAL” while depressed. The Green RUN LED will flash. After releasing the button, the display will indicate an oxygen concentration value. Adjust the digital display to read the correct concentration of oxygen by pressing the UP or Down arrows as required.

Press the “MODE” button again to scroll past the “ALM1” , “ALM2”, and Fault Modes as indicated on the display.

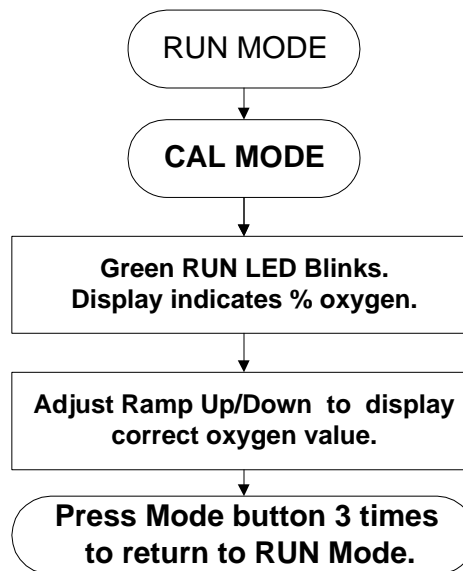

**FIGURE 29  
CAL MODE DIAGRAM**

Calibration gas should be applied to the analyzer at a similar flow rate and pressure to that of the sampled gas. Be sure to allow the calibration gas to flow to the sensor until the display has stabilized. The stabilization period allows time for the calibration gas to flush the gas in the sampling lines.

The Model 7100P Portable analyzer will resume normal RUN mode operation when the UP, DOWN, or MODE buttons have not be pressed within a 120 second period.

### 3.3 SET OR VIEW ALARMS

Alarms 1 & 2 are indicated by a red LED plus dry relay contacts. The alarms will be indicated when the oxygen concentration has violated the threshold criteria of the respective alarm setpoint. The Alarm status will be cleared when the alarm condition has ceased.

The alarm relay conditions will be “frozen” when entering the calibration or set alarm modes. The alarms will be re-enabled two minutes (factory default) after no buttons have been pushed.

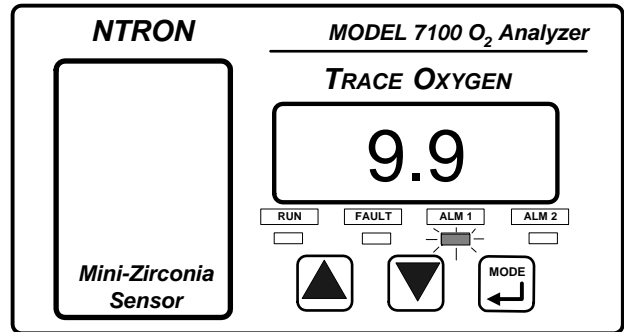

*Ascending or Descending Trip?* Alarms may be configured with ascending or descending trip. An ascending trip means the alarm will activate due to an increase in oxygen concentration above the setpoint programmed into the Model 7100. Descending trip will cause an alarm to activate due to a decrease in oxygen concentration below the setpoint programmed into the Model 7100. The oxygen concentration setpoints are programmed as described below.

*Fail Safe or Non-Fail Safe?* Optional Relay Alarms may be configured as fail safe or non-fail safe. This choice is provided to those customers who may prefer an alarm configured in a particular manner for safety reasons. Many companies prefer alarm relay actions to default to alarm condition when power to the instrument is lost. That is, the relay contacts are the same as for alarm condition as for a lost power condition. This is “Fail Safe”.

*In fail safe configuration, the alarm relay coils are de-energized in alarm mode and energized in normal operating (non-alarm) state.*

In contrast, an alarm configured as Non-Fail Safe operates such that the relay coils must be energized to activate an alarm condition. When power is lost to the instrument, the relay contacts default to their normal non-alarm state.

*In non-fail safe configuration, the alarm relay coils are energized in alarm mode and de-energized in normal operating (non-alarm) state.*

*What is the factory setting?* Alarm Relays 1 & 2 are factory set to non-fail safe and to Ascending trip. These settings may be changed in the field by accessing the main circuit board jumper configurations. If specified at the time of the order, Neutronics will configure the alarm relays to the customer specification. Refer to the certificate of analysis that accompanies every shipment and to the appendix of this manual.



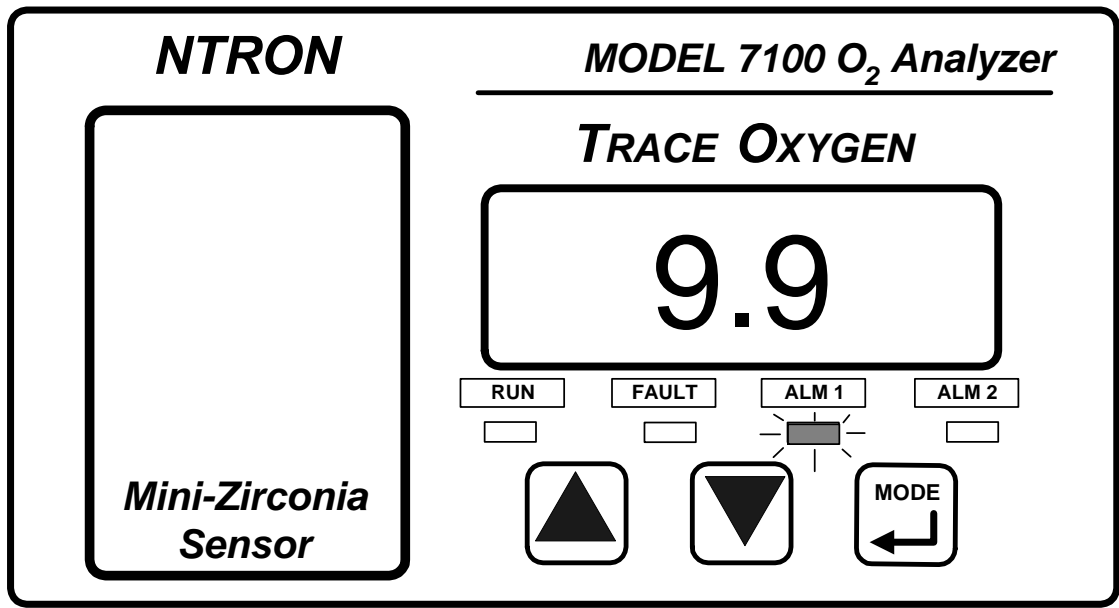

*Setting the alarm points:*

After the unit has been calibrated on a known gas source, it is desirable to set the alarm points. Scroll through the menu by pressing the “MODE” button until “ALM1” is displayed. Adjust the up and down buttons accordingly. Then, press the “MODE” button again to scroll to “ALM2”. Adjust the display as required. Press the MODE button once again and the unit will scroll to the FAULT mode. A fault number will be displayed if one is detected. Press the mode button again to return to normal RUN mode. A time-out is built in to the unit. After approximately 120 seconds, if no buttons are pressed, the unit will return to normal RUN mode.

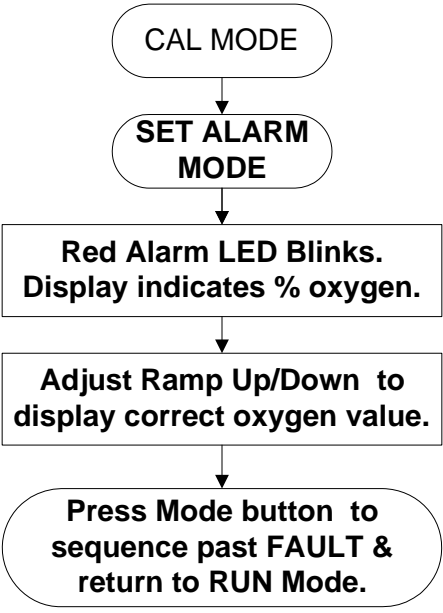

**Figure 30: Set Alarms Diagram**

### 3.4 FL – Diagnostic Fault display

The FAULT mode will be indicated when the analyzer has detected a possible problem with calibration, hardware, or software. In addition to the yellow LED, a relay contact (SPST- N/O) is provided. Relay is energized in Fault mode. While in this mode, use the INC and DEC keys to view all the possible faults. A display of 'FL ' indicated no fault.

Use the table below to determine the possible fault:

- 14 Sensor Heater Temperature Error
- 13 User calibration too small
- 12 User calibration too large
- 11 Non-native display range (flashing)
- 10 Sensor appears to be open
- 8 A concentration reading is not yet available
- 7 A/D appears to be defective
- 6 Analog Output Range Underflow
- 5 Analog Output Range Overflow
- 3 Device is in setup mode (via serial port)
- 2 Relays are in standby mode
- 1 Sensor Heater is warming up

FAULT LED and relay contacts will reset automatically once the error has ceased. The FAULT condition status on the analyzer may be cleared by entering the calibration mode. If the fault has not cleared after calibration, the FAULT LED and relay contact will be re-enabled.

### 3.5 ALARM ACTIVE MODE: ALARMS 1 or 2 are in alarm state

Alarm Active mode is indicated by a red ALM 1 LED or ALM2 LED. The analyzer has detected an alarm condition as determined by the alarm set up. As you will recall, Optional Alarm relays 1 & 2 may be configured as ascending or descending trip, Fail-Safe or non Fail-Safe. Furthermore, the user may field set the alarm point to any PPM oxygen value within the range of the analyzer. In addition to the red alarm LED, Form C (SPDT) relay contacts are provided for each alarm.

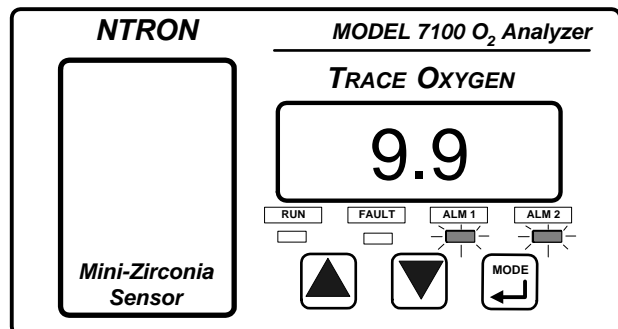
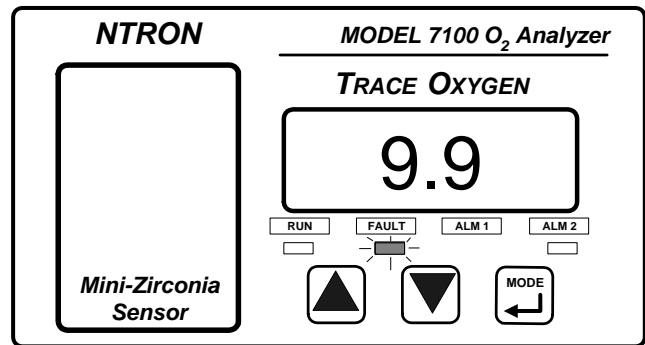

# CHAPTER 4

## Analog Outputs

The Model 7100P Portable analyzer provides three analog outputs:

- DC Voltage for oxygen concentration: 0-1, 0-5, or 0-10 VDC (jumper selectable)
- DC Current for oxygen concentration: 4-20 mA
- DC Voltage for range Identification:
 

0-10 ppm .....	3.13 Vdc
0-100 ppm .....	3.75 Vdc
0- 1000 ppm .....	4.38 Vdc
0- 2000 ppm .....	5.0 Vdc

**NOTE: the analog voltage output (0-1 or 0-5 or 0-10 VDC) must be set by the hardware jumpers.**

Connection to the outputs are made at the terminal blocks on the rear of the analyzer chassis. The terminal blocks are removable for easy installation of the wires. Be certain to match the terminal pins against the terminal ID label on the top of the analyzer chassis.

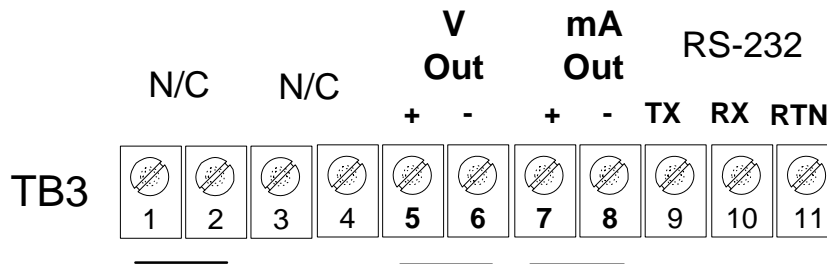

Two wires are required for each output. Individually shielded twisted pairs using stranded wire conductors are suitable for the connections. The shield should be drained to dc ground at the auxiliary equipment.

The voltage and current outputs for oxygen concentration are linear and follow the analyzer display readings.

The default for analog voltage output for oxygen concentration is 0-1 VDC. This is field changeable through PCB jumpers, see the Appendix. The analog voltage output follows the range with 0vdc always = 0% oxygen.

The 4-20 mA output is negative ground, non-isolated. The 4-20 mA output loop power is supplied by the Model 7100P Portable analyzer. The analog current output follows the range with 4 mA always = 0 ppm oxygen.

When the analyzer is configured for auto range mode, it may be necessary to monitor the optional range ID voltage output. This additional output will identify the current range of oxygen measurement.



# CHAPTER 5

## Optional Alarm Outputs

The Model 7100P Portable analyzer can be purchased with three optional alarms outputs:

1. Alarm 1, settable for concentration of oxygen (1 Form C relay contacts SPDT can be configured for fail safe or non-fail safe / ascending or descending trip. See section 3.3)
2. Alarm 2, settable for concentration of oxygen (1 Form C relay contacts SPDT can be configured for fail safe or non-fail safe / ascending or descending trip. See section 3.3)
3. FAULT Alarm , factory set to alarm when a fault is detected (see section 3.4). The fault alarm relay contacts are 1 Form B SPST and is always configured fail-safe.

Connection to the optional outputs are made at the terminal blocks on the rear of the analyzer chassis. The terminal blocks are removable for easy installation of the wires. Be certain to match the terminal pins against the terminal ID label on the top of the analyzer chassis.

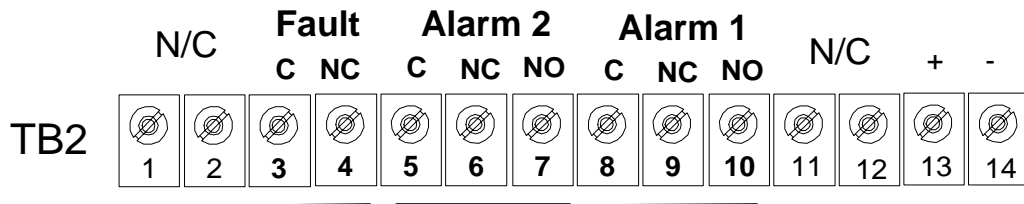

# CHAPTER 6

## Service Port: Serial Communications Interface

The model 7100P Portable analyzer features a service port which is accessible for monitoring the analyzer output and for determining the active fault codes. The service port has been designed for communication with a PC based computer (such as a Portable analyzer notebook computer) over a standard RS-232 serial interface.

**6.1** There are three levels of access through the service port:

1. **STANDARD ACCESS:** ASCII dump to a PC, printer or DAQ and provides basic operator access.
2. **ADVANCED LEVEL 1 ACCESS:** Allows setup and configuration of alarms, data format...
3. **ADVANCED LEVEL 2 ACCESS:** Allows access to vital control areas via password.

I. The **standard access** is available to the user via a host computer or printer over a standard RS-232 serial interface. The host computer can forward inquiries about sensor temperature, oxygen concentration, sensor voltage, and other parameters. The host computer may control analyzer electronics, via the communications interface, by turning the communications line on or off.

**NOTE!** If a computer is on line with the analyzer, a restart may be accomplished either by simultaneously holding the “mode” and “UP” buttons on the model 7100P Portable analyzer display panel for approximately 10 seconds or by turning the analyzer off and then on.

The commands are :

“A” returns the Short Software Version

“C” returns the Device Type

“E” returns the Device output in PPM O2

“H” returns the Fault Code

“I” returns the Fault Descriptions

“V” returns the Long Software Version

“@” returns the Neutronics Inc. Serial Number

S SERFMT=0 Disables RS 232 output

S SERFMT=1 Enables RS 232 output in HUMAN READABLE format

S SERFMT=2 Enables RS 232 output in MACHINE format w/o Checksum

S SERFMT=3 Enables RS 232 output in MACHINE format w/Checksum

S SERFMT=4 Enables RS 232 output in TAB DELIMITED (Excel) format.

S SERFMT=5 Enables RS 232 output in OA1 format.

The communications Interface can be operated at several BAUD rates, the factory default is 9600 BAUD. To operate the interface, the host sends an ASCII command letter to the analyzer. The host computer then waits for the analyzer to respond. The analyzer responds no later than 0.5 second after it receives the command letter. All responses are terminated with a carriage return. Data will be sent out the RS232 to the host terminal every 1.0 seconds. To end the communication, enter “S SERFMT=0”.

There are several timed update formats of the ASCII dump available:

- 0 none Timed Outputs disabled
- 1 Human Output tailored to reading by human
- 2 Machine, no checksum Output tailored to use by a host computer
- 3 Machine w/ Checksum Output includes a trailing Checksum to insure data integrity
- 4 Tab Delimited Output for MS EXCEL file format

The default format is **Human readable**. Configuration of the Service Port timed format is available through the advanced level 1 interface. The format of the Human readable data is:

*Mode Reading Units ALM1 ALM2 FLT ↵* (see notes 1,2,3)

The format of the **Machine, no checksum** data is:

*Concentration Reading/range Device type Code Fault Code Alarm 1 active Alarm 2 active  
Display range code ↵* (see notes 1,2,3)

The format of the **Machine, w/ checksum** data is:

*Concentration ReadingRange DeviceType FaultCode Alarm1Active Alarm2Active  
DisplayRangeCode CRC Checksum ↵* (see notes 1,2,3)

The format of the **Tab Delimited** data is:

*Seconds since unit powered on<sup>tab</sup> Mode<sup>tab</sup> Concentration<sup>tab</sup> Range ID<sup>tab</sup> Alarm1Active<sup>tab</sup>  
Alarm2Active<sup>tab</sup> Fault ↵* (see notes 1,2,3)

#### Notes:

1. The Fault Code, FLT is output only if active, otherwise, it is deleted from the string.
2. The Fault.L code is represented by the Error messages listed in the FAULT section of this manual. The Fault code is bitwise (one bit in the code represents 1 fault). It is a 32 bit number, with fault number 1 (Oven or sensor is warming up) being the most significant bit, which would be 80000000 in hexadecimal. A typical fault code during warn up for a model 7100P Portable analyzer would be C0040000 in hex, which would represent fault codes 1, 2 and 14.
3. Alarm Active is represented by "1", alarm not active is represented by "0".

II. The **Advanced Level 1 Access** is available to the user via a PC or directly at the Model 7100P Portable analyzer control panel. Access to level 1 can be accomplished on a PC by typing "setup" when viewing the standard ASCII dump. A series of menus will display on the PC screen allowing access to changing the setup configuration. Some features of this level access may also be initiated directly at the Model 7100P Portable analyzer by pressing in the mode button for 5 seconds.

**NOTE: Do not attempt advanced level 1 or 2 access without reading "Service Port : Changing the factory settings" section of the appendix.**

III. The **Advanced Level 2 Access** is available to the user via a PC by use of a password. This level access allows manipulation of code settings and should only be attempted with direct consultation with our applications engineering staff.

Connection to the Service Port can be made at the terminal blocks on the rear of the analyzer chassis. The terminal blocks are removable for easy installation of the wires. Be certain to match the terminal pins against the terminal ID label on the top of the analyzer chassis.

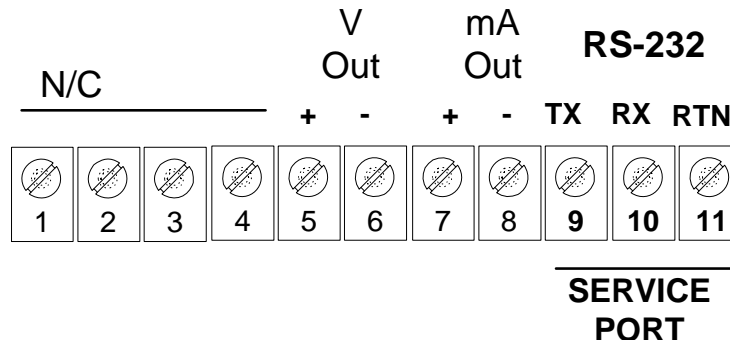

Access to the Serial Service Port may be made through a terminal emulator program such as HyperTerminal available in Windows 95/98:.

### Procedure for RS-232 Service Port Interface using “HyperTerminal” from Microsoft Windows 95

1. From the Windows menu, select “**Start**”.
2. Then, select “**Programs**”.
3. Then, select “**Accessories**”.
4. Then, select “**HYPER TERMINAL**”.
5. Double click on the HyperTerminal Icon.
6. Choose name “Model 7100”.
7. Choose code: none required.
8. Choose area code: none required.
9. Connect Using:

Direct to SERIAL COM 1 or SERIAL COM 2 (as applies)  
 BPS: 9600 BAUD (factory default, see appendix)  
 Data Bits: 8  
 Stop Bits: 1  
 Parity: none  
 Flow Control: none

10. Click “OK”
11. The Model 7100P Portable analyzer will commence sending data via ASCII code dump to the monitor or printer. The information from the analyzer will be sent in ASCII strings at 1 second intervals. Data will be sent in the following factory default format (human readable).

## Notes:

If serial communications has not been established with model 7100P Portable analyzer, make certain that the PC SERIAL COM port is functional. This can be accomplished by jumping pins 2&3 on the RS 232 cable leading to the PC. To accomplish this test, disconnect the RS 232 cable from the model 7100P Portable analyzer port and insert a jumper between pins 2&3 on the cable connector or directly at the PC serial COM port. Then, enter a letter from the PC keyboard : push an alpha-character key and then “enter” key. The PC monitor should display the corresponding alpha-characters as they are typed. If the alpha-characters do not echo on the monitor screen, there is a problem with the RS 232 cable, the PC serial COM port, or the HyperTerminal setup.

If the letter does echo on the monitor screen and serial communications with the model 7100P Portable analyzer still has not been established, then pins 2&3 (xmtr & rcv.) may be reversed. First try reversing pins 2 & 3 on the RS – 232 cable connector. Then go back to the beginning of step #1 and try again. If the model 7100P Portable analyzer still does not re-boot, call the Neutronics Inc. Service Department for further assistance.



# CHAPTER 7

## Maintenance

Maintenance for the Model 7100P Portable analyzer is very simple. Apart from the normal maintenance for any instrument such as cleaning the chassis & wiping the display, the Model 7100P Portable analyzer does not require any major servicing. Periodic calibration of the sensor on known gas should be performed on a regular basis (see section problems

Recommended Frequency → Task ↓	At Commissioning	Every 6 months	Every Year	As Required
Calibrate Sensor	✓ <i>optional</i>	✓		✓
Clean the analyzer chassis and display panel with soft cloth. Make sure the ventilation ports are clear.			✓	✓
Configure alarms	✓			✓
Check the analog outputs and RS-232 output against display	✓		✓	
Install New Oxygen Sensor				✓ Every 3-5 YEARS

# CHAPTER 8

## Trouble-Shooting

In some cases problems can be easily diagnosed and corrected. In other cases problems may require the user to return the analyzer to the factory for repair. Contact the customer service department identified at the front of this manual with any questions or when uncertain.

### **Problem 1: Display reads too high.**

**Cause:** Upset system condition indicates one of the following:

- ⇒ Gas source contamination
- ⇒ Gas delivery system integrity failure
- ⇒ Insufficient time was given to allow a high concentration of oxygen in the sample gas to clear the sample line.

**Solution:**

- ⇒ Ensure the sample gas source supply is on.
- ⇒ Check gas delivery system for leaks and then repair (tubing connections).
- ⇒ Be certain to allow sufficient time for sample gases to purge out of the sample line when the model 7100P Portable analyzer undergoes large step changes from high oxygen to low concentrations of oxygen. On a cold start up of the 7100, it may take up to 30 minutes to read oxygen concentrations below 100 ppm if the unit was exposed to air for more than 5 minutes during power up. It is recommended to purge the unit for 5 to 30 seconds before power up. This will help purge the system of excess oxygen before activating the sensor. Simply apply a nitrogen (or other inert gas) supply of about 1-3 psig into the sample inlet port of the model 7100. Let the gas purge through the analyzer for about 5-30 seconds. Then you can power up the unit. The biggest delay in reading oxygen from a cold start is the time required to purge the sample tubing free of oxygen.

**Cause:** Improper calibration.

**Solution:** This can be checked by flowing a certified gas through the analyzer to compare the reading with the O<sub>2</sub> concentration documented on the gas cylinder certification tag. If needed, recalibrate the analyzer as described in Chapter 4.

**Problem 2: Display reads too low.**

**Cause:** Improper calibration or sensor is failing.

**Solution:** Recalibrate and/or install a new sensor as required.

**Problem 3: Erratic or intermittent display.**

**Cause:** If line power has been temporarily interrupted, the analyzer will restart itself.

**Solution:** Avoid using the 7100P during electrical storms or when the power may be interrupted (during plant maintenance for example). It is also advisable to provide a power line conditioner in areas where the mains power may experience fluctuations outside of the listed specifications. It is also recommended to install a Lightning Protection Unit (LPU) on the line power when the instrument is to be used in an area where lightning is commonplace and may create a high power surge on the instrument. The practices listed above are not unique to the Model 7100P Portable analyzer instrument, but are standard recommended practice for all instrumentation.

**Cause:** Failure of an electronic component. It is always possible for a component to fail and render the analyzer inoperable. While the Neutronics Inc. Oxygen Analyzer has been designed with rugged components, the possibility of failure is always present.

**Solution:** In the event of a major component failure, we suggest the device be returned to the manufacturer's facility for repairs. However, in certain instances you may wish to attempt field repairs. Sensors are replaced easily. A trained service technician should only attempt major failures such as an electronics board replacement. It is strongly recommended that the technician reference the model 7100P Portable analyzer manual for repairs. Additional copies of the manual are available through order with the Neutronics Inc. Customer Service Department.

# Appendix

Contents:

- A: Spare Parts Listing
- B: MSD Data
- C: Service Port: Changing the Factory Settings
- D: Additional Drawings

## **A: Spare Parts Listing**

### ***Minor Spare Parts:***

VAC Fuses for VAC Power Supplies

Operations Manual

Replacement filter elements

Sample Tube

Power Cable

Rubber feet

### ***Major Spare Parts:***

Oxygen Sensor Board

VAC Power supplies

Optional Relay Board

Main CPU Board

Replacement terminal blocks: TB1 or TB2 or TB3

## B: Material Safety Data (MSD)

... use as guide only, contact Neutronics Inc. for more information.

1. **Product Identification:** Oxygen sensor, Solid State Type, Model ZrO2  
Furnished by Neutronics Inc. Inc., 456 Creamery Way, SLC, Utah 19341  
T: (801)972-2455

---

2. **Hazardous Ingredients of Solution:**

none

---

3. **Health Hazard:** none

---

4. **Physical and Chemical Data:**

Yttria stabilized Zirconia element with platinum electrodes and heater element

No information available. Contact Neutronics Inc. for more information if needed.

---

**Unusual Fire & Explosion hazards:** none

---

6. **Health Hazard Data:**

No hazards are encountered during normal operation. Do not touch heated cell. Allow unit to cool down before servicing.

---

7. **Emergency and First Procedures:**

Skin Contact: If hot sensor is touched, immediately flush skin with cool water.

---

8. **Handling:**

- **Protective measures during cell replacement:**

- ◇ Do not remove sensor from analyzer while the instrument is powered or while the sensor is still hot.

*Note: The above data is based on MSD provided by the manufacturers of components and by tests conducted by Neutronics Inc.. Neutronics Inc. believes that this information to be accurate and reliable. This information is supplied as reference only. Neutronics Inc. disclaims any liability for damage or injury which results from the use of the data and nothing contained therein shall constitute a guarantee, warranty, or merchantability or representation by Neutronics Inc. Inc. with respect to the data, the product described, or their use for any specific purpose, even if that purpose is known to Neutronics Inc. Inc.*

## **C: Service Port – Changing the factory settings:**

The model 7100P Portable analyzer features the ability to manually alter the factory setting for serial output format, range selection, alarm relay configuration, analog output, and diagnostics. Changing the factory defaults may be accomplished through four methods:

- **Hardware Jumper** selection on the main circuit board..... **OR**
- **Level 1 access through the 7100P Portable analyzer keypad**..... **OR**
- **Level 1 access through serial interface of the service port**..... **OR**
- **Level 2 access through serial interface of the service port**

### **C.1 To change the factory settings by accessing the HARDWARE JUMPERS:**

***Range selection and analog voltage output may be configured using the hardware settings. These changes can also be made directly through the software via the RS-232 interface. Other changes to the factory settings must be made by accessing level 1 software either through the front panel keypad or through the service port serial interface. See C.2 or C.3***

***NOTE: the analog voltage output the hardware jumpers must set (0-1 or 0-5 or 0-10 VDC).***

1. Ensure sure that all interface to the model 7100P Portable analyzer is disabled at the user device. Ensure that interrupting the alarms, outputs, etc... will not interfere with normal process monitoring.
2. Disconnect power from the model 7100P Portable analyzer unit.
3. Remove the top cover from the analyzer. Remove the two screws retaining the black plastic access plate on the rear chassis. Remove Set the access plate aside. With the access plate removed, you now have entry to the optional output terminal blocks. Unplug and remove the terminal blocks. There are two screws that hold the chassis to the control module. Remove these two screws.
4. Disconnect the plastic tube from the exhaust port of the control module (this tube leads to the flowmeter bottom port). Disconnect the SS tubing from the sample inlet port of the control module (this leads to the check valve and pump).
5. Remove four nuts retaining the control module to the front panel of the 7100P chassis. Slide the control module out.

6. Remove the screws/lockwashers holding the rear chassis of the control module on.. Set these aside for re-assembly. Slide the control module chassis off.
7. Turn the control module upside down so that the bottom of the main board is face up.
8. Identify the appropriate jumper position. Remove a jumper from the unused position and place into the selected position.... See tables following.
9. Reassemble.
10. Reapply power. Perform a calibration check.
11. Check functions of changes to ensure jumpers are recognized by the model 7100.
12. If no problems are noted, continue with normal operation, ELSE, recheck the configuration of jumpers using the steps listed above. If problem persists, contact the service department from the issuing agent.

**Fig.C1: Jumper - Location:**

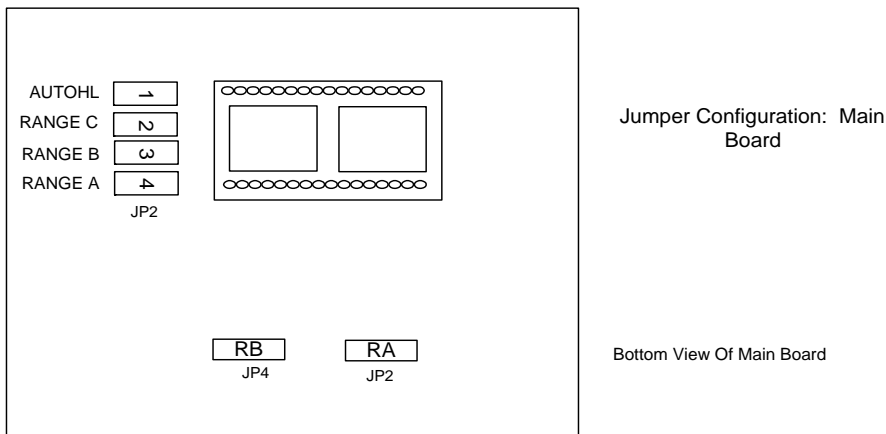

Control Panel Setting	JP2 Jumpers				Function
	AUTO	C	B	A	
8	1	0	0	0	Auto Range
1	0	0	0	1	FIXED 10 PPM
2	0	0	1	0	FIXED 100 PPM
3	0	0	1	1	FIXED 1000
4	0	1	0	0	FIXED 2000 PPM

**TABLE C2: Control Panel setting and Jumpers for Range Select**

**TABLE C3: ANALOG VDC out jumpers**

JP4 / JP5 Jumpers		Function
RA	RB	
1	0	Vout= 0-1 volt
0	0	Vout= 0-5 volt

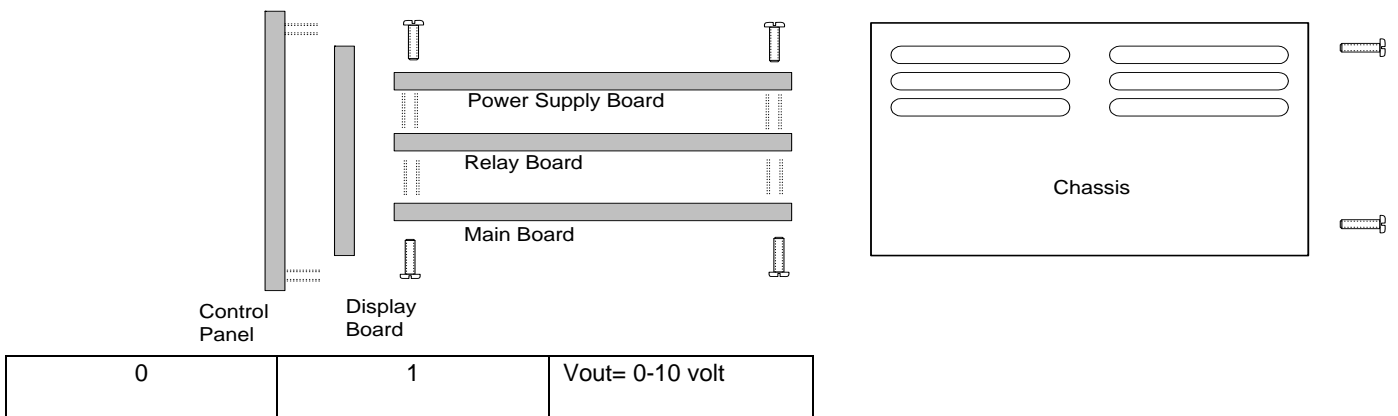

**Figure C.2: Accessing the Hardware Jumpers**

**C.2 To change the factory settings by accessing the Level 1 software at the FRONT PANEL KEYPAD:**

*In level 1 software (via the front keypad), you can change:*

- *Measurement Range: fixed or auto range*
- *Alarm relays are ascending or descending trip*
- *Analog output configuration*
- *Alarm relay operation: Fail safe* Location Of Jumpers
- *Service Port (serial interface) Baud Rate*



**Table C3: Operational Table**

Range Name	Measured Range	Display	Analog Range	Range Voltage Output
<b>Auto Range</b>	0-10 ppm 10-100 ppm 100-1000 ppm 0-2000 ppm	X.X XX. XXX. XXXX.	0...10PPM 0... 100 PPM 0 ...1000 PPM 0 .....2000 PPM	3.13 Volts 3.75 4.38
<b>Fixed Range: 10PPM</b>	0-10PPM	X.X	0...10PPM	3.13
<b>Fixed Range: 100PPM</b>	0-100PPM	XX.X	0...100PPM	3.75
<b>Fixed Range: 2000PPM</b>	0-2000PPM	XXX.X	0...2000PPM	4.38

**Procedure to access settings at the 7100P Portable analyzer keypad:**

- 1 To configure the 7100P Portable analyzer measurement range(s) through the front panel keypad, you must remove all four of the hardware jumpers.
- 2 To enter the User configuration via the 7100P Portable analyzer keypad, Press and hold the MODE button for 10 seconds. The display will show “---”. Release the mode button. You are now in the setup mode, **range setting**.
- 3 The display will show “A 1”. Pressing the mode key will scroll through the User configuration Modes.

MODE	INITIAL DISPLAY READING WHEN SCROLLING
<b>USER CONFIGURATION A: SET RANGE</b>	<b>A 0</b>
<b>USER CONFIGURATION 1: ALARM 1 TRIP</b>	<b>1 0</b>
<b>USER CONFIGURATION 2: ALARM 2 TRIP</b>	<b>2 0</b>
<b>USER CONFIGURATION 3: ANALOG OUTPUT</b>	<b>3 0</b>
<b>USER CONFIGURATION 4: SET SERIAL OUTPUT</b>	<b>4 0</b>
<b>USER CONFIGURATION 7: SET ZERO RANGE</b>	<b>7 0</b>
<b>USER CONFIGURATION 8: RESTORE FACTORY SETTINGS</b>	<b>8 0</b>
<b>USER CONFIGURATION E: SET VOLTAGE TO 110 OR 220 vac</b>	<b>E 0</b>
<b>USER CONFIGURATION F: SET FAIL SAFE</b>	<b>F 0</b>
<b>USER CONFIGURATION b: SERIAL BAUD RATE</b>	<b>b 0</b>
<b>FPT: FRONT PANEL TEST</b>	<b>“ - “ , then “ - - - “ after 10 seconds</b>

4 The instrument **range** may be selected by the hardware jumpers or by this software range setup. To use the software setup, you must remove all of the four hardware jumpers.

**In the any fixed range, if the measured concentration is outside of the selected range or outside of the display's ability, the value will be shown in PPM oxygen, and the display will flash. Analog Output ranges never extend.**

5 **USER CONFIG. A:** Display will read 'A 0' **Set RANGE:** see table C1 UNDER "Control Panel Setting"

6 **USER CONFIG. 1: Alarm 1 Trip:** Use the UP and DOWN arrow keys on the 7100P Portable analyzer display to change this value

from 0 to 1: 1 = descending alarm 1 0 = ascending alarm 1

7 **USER CONFIG. 2: Alarm 2 Trip :** Use the UP and DOWN arrow keys on the 7100P Portable analyzer display to change this value

from 0 to 1: 1 = descending alarm 2 0 = ascending alarm 2

8 **USER CONFIG. 3: Analog output:** 0 = 0.0 to 5.0 vdc, 1 = 0.0 to 10.0 vdc, 2 = 0.0 to 1.0 vdc

**VIEW ONLY: analog outputs only configured by hardware jumpers!**

9 **USER CONFIG. 4: SERIAL (SERVICE) PORT OUTPUT FORMAT** The Serial Service Port Output can be configured for several output modes.

In the standard access, the PC or printer will receive a steady stream of information via an ASCII dump. Information includes oxygen concentration, alarm status, mode status, and Fault status. There are several timed update formats of the ASCII dump available:

- none Timed Outputs disabled
- Human Output tailored to reading by human
- Machine, no checksum Output tailored to use by a host computer
- Machine w/ Checksum Output includes a trailing Checksum to insure data integrity
- Tab Delimited Output uses tabs and may be used by a printer, host computer, or DAQ (EXCEL)

CODE	Serial Output Type
0	None
1	Human
2	Machine No Checksum
3	Machine with Checksum
4	Tab Delimited (Excel)
5	OA1 style format

The default format is **Human readable**. Configuration of the Service Port timed format is available through the advanced level 1 interface. The format of the Human readable data is:

*Mode Reading Units ALM1 ALM2 FLT ↵*

**Machine, no checksum** format of data:

*Concentration Reading/range Device type Code Fault Code Alarm 1 active Alarm 2 active Display range code ↵*

**Machine, w/ checksum** format of data:

*Concentration ReadingRange DeviceType FaultCode Alarm1Active Alarm2Active DisplayRangeCode Checksum ↵*

10 **USER CONFIG. 7: Zero Range Code:** The model 7100P Portable analyzer allows for a two point calibration.

The first point should be an air cal. The second calibration point, "Zero Range Code" , should be carried out with a certified gas of a concentration of oxygen near or in the range of primary measurement (For example, 0% oxygen in nitrogen). This lower point calibration, or the Zero Point, may be chosen from the list of ranges in the following table:

**Table C.4 Zero Range**

Entered Value	Range
0	Single Point Calibration
3	0.0 – 5 ppm
4	0.0 – 50 ppm
5	0.0 – 500 PPM

**11 USER CONFIG. E: Set Unit Supply Voltage to 110 or 220 VAC (applies only to VAC power supply models). 0 = 110 VAC power, 1 = 220 VAC operation. This setting only affects warm up time at power up of unit. The sensor will warm up quicker in the proper setting, no damage occurs to the unit in the wrong setting.**

**12 F: Fail Safe Relays:**

1 = Alarm 1&2 relays are in fail safe mode (relay coils are energized in non-alarm condition, de-energized in power off or in alarm condition.

0 = Alarms 1 & 2 relays are in non-fail safe mode (relay coils are de-energized in non-alarm condition or in power off, energized in alarm condition.

**13 USER CONFIG. b: Service Port Baud Rate:**

CODE	Baud Rate
0	110
1	300
2	1200
3	2400
4	4800
5	9600
<b>6</b>	<b>19200</b>
<b>7</b>	<b>38400</b>

**14 USER CONFIG. C: CLEAN MODE**

Does not apply to model 7100

## 15 USER CONFIG 8: Display shows '8 0' – Restore Factory Settings

This mode allows the operator to restore the instrument to the factory set points. This includes all calibrations, alarms and baud rates. To perform this function, press the "UP" button until the display shows 8 88, then press the mode button. If you do not wish to perform the factory restore, press the mode button with any other number on the display.

## 16 FPT - Front panel test

The FPT is available from the keyboard to allow the factory and users to quickly determine if the front panel is working correctly. To enter the FPT, press and hold both the INC and DEC keys. The display will show '—' until the INC and DEC keys have been held for 10 seconds. The display will then change to '---'. Upon entry to the FPT, the serial port will output: "Entering Lamp Test." and the display will begin displaying characters, one at a time. If you press the front panel INC key (or the PCB INC key) the display will show 'UUU'. Pressing the DEC key results in 'ddd' and pressing the MODE key shows '==='. To exit the FPT, press and hold both the INC and DEC keys until ' - - ' is shown, then release the INC and DEC keys to resume normal operation.

**17 If a computer is on line with the analyzer, a restart may be accomplished either by simultaneously holding the "mode" and "UP" buttons on the model 3100 analyzer display panel for approximately 10 seconds or by turning the analyzer off and then on.**

## Er.0 Starting a System for the first time

***Two identical copies of the system's setup information are stored in the EEPROM. If both copies are damaged (the program determines this by inspecting the CRC16 of the data) the device will refuse to run. ' Er.0' will be displayed on the front panel and the device is locked with the fault light and relay ON. The only way out of this error is to perform a factory initialization that can be reached through the Setup Mode with a serial terminal.***

## C.3 To change the factory settings through the Software Interface (RS-232 port):

Use a terminal or terminal emulator (like the Windows 95 HyperTerminal) to interactively test and configure the analyzer. See Section "Service Port" of this manual. Connect your terminal, set the communications parameters to 9600 baud, 8 data bits, 2 stop bits, no parity, no hardware or software handshaking. Terminal emulation must be VT100 or VT200.

Turn on the analyzer's power and wait for the Software Version number to be displayed. The terminal emulator should then display @@@ then the Model, serial number, version number and the baud rate.

Regardless of the serial output format previously selected, type SETUP and press enter from the Terminal emulator.

The instrument will enter the User Setup Menu and the instrument display will show ' SU '.

Follow the on screen prompts to change or configure the instrument. NOTE: the F3 key is the exit button. You will be prompted to save or discard your changes upon exiting.

From this first menu, you have access to general system information, the relay and analog output configurations, the instrument display range, and the operator lockouts etc.:

```
*****> SETUP MAIN MENU <*****          (U00)
Press To Change          (F3-Exit Setup Mode Now)
- - -----
1 I System Information
2 R Alarm Relay Setup
3 A Analog Output Setup
4 G Display Auto-Range Setup

5 S Serial (RS-232) Output Setup

6 Operator may change Alarm Setpoints: Yes
7 Operator may change Calibration Reading: Yes
8 Operator may use the User Menu: Yes

9 Z Assume Low End Calibration when concentration: 5-> 0.0 to 500 PPM

  T Calibration Mode Auto Return to Run after 120.0 seconds

0 L 220 Volt Line Voltage: No

Q Esc Quit, return to the previous menu

->
```

**Notes:**

- The service port allows more setup and diagnostics choices. Items #6,7,8 in the box above allow you lockout users from accessing certain features through the model 7100P Portable analyzer keypad.
- Item #9 in the box listed on the previous page refers to setting the low end calibration point (or actually, the range of concentration in which the lower end calibration will occur).
- Item #9T in the box on the previous page refers allows you to set the amount of time the alarm relays are disabled after leaving calibration mode. This time is set in total seconds of wait time. The wait time is useful for those instances when the calibration is of a concentration of oxygen which would normally create an alarm condition. By allowing a 120 second wait period, the model 7100P Portable analyzer will not enable the alarms for 120 seconds after exiting the calibration mode. Choose a limit of time which will allow sufficient time for the sample tubing to be cleared of the calibration gas and replaced with normal process gas.
- 0 L refers to the mode for setting the operational voltage: 120 or 110 volts AC. **You must select the proper voltage before operating the model 7100.**

**D: Additional Drawings ...**

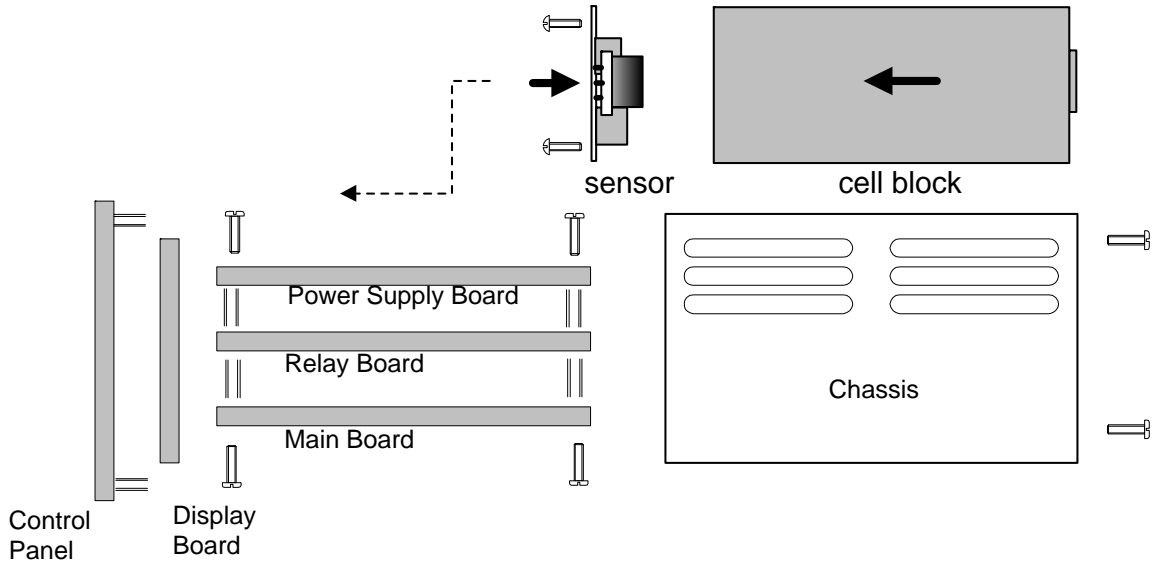

**MODEL 7100 SENSOR INSTALLATION DETAIL**

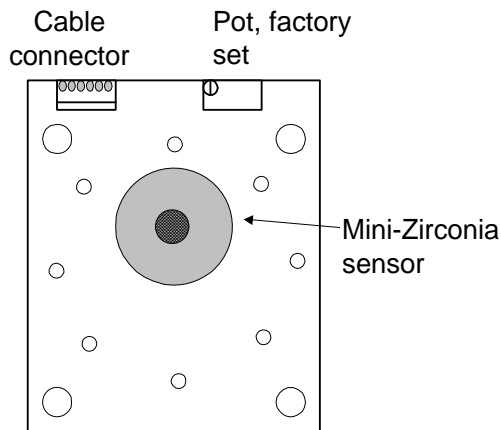

**Top View  
Mini-Zirconia Oxide Sensor  
w/ heater control board**

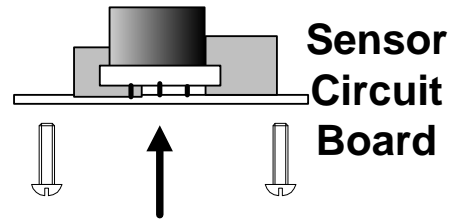
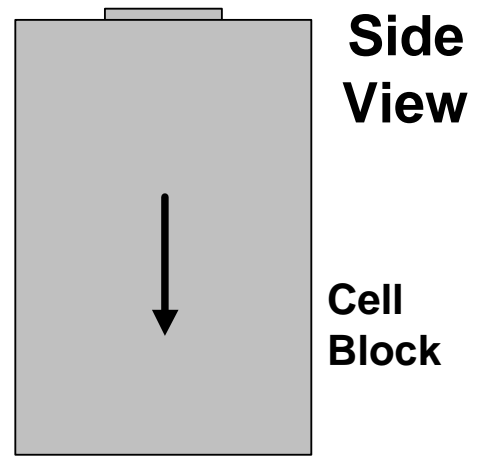

**MINI-ZIRCONIA SENSOR /  
CONTROLLER BOARD**

**Figure E: Driving Motors with the optional alarm relay contacts**

Model 7100  
Alarm Contacts

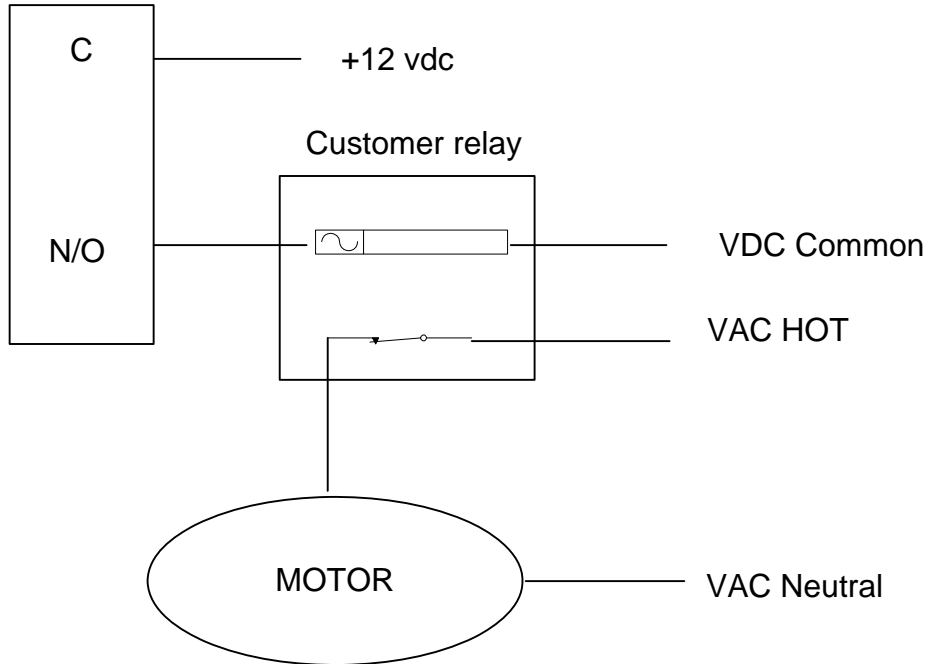

## Quick Operation Instructions

Model 7100P Portable analyzer

### START UP

1. Connect the sample gas inlet (1/8 inch NPT female port). Regulate to 1-3 PSIG.
2. Flow inert gas to sensor for 5 seconds or more.
3. Turn on power to Model 7100P Portable analyzer.

### **Warm Up:**

As the Sensor is warming up to operating temperature, the Analyzer display alternates between flashing the time remaining (seconds) .....and “nr” for *not ready*.

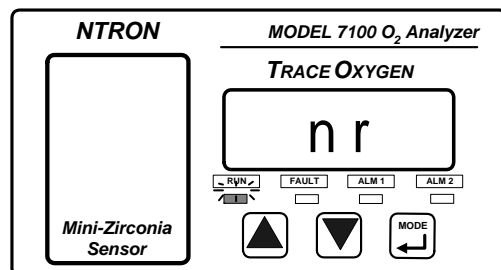
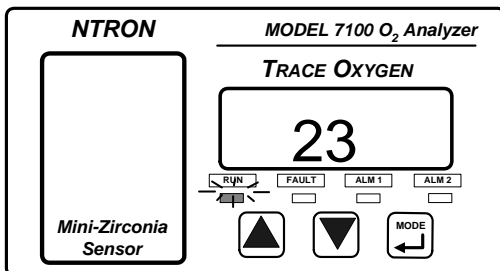

Total warm up time to reach best performance: approximately 5 minutes.

It takes about 3 minutes to warm up from a cold start. It takes about another 5 minutes to attain best signal stability.

Always expose the sample inlet port to nitrogen (or inert gas flow) before power up of the 7100P Portable analyzer to purge resident oxygen from the sample lines and sensor.

### **Single Point CALIBRATION**

1. Apply calibration gas to input port of model 7100P Portable analyzer at 1-3 psig (1 cfm).
2. Press "MODE" button.

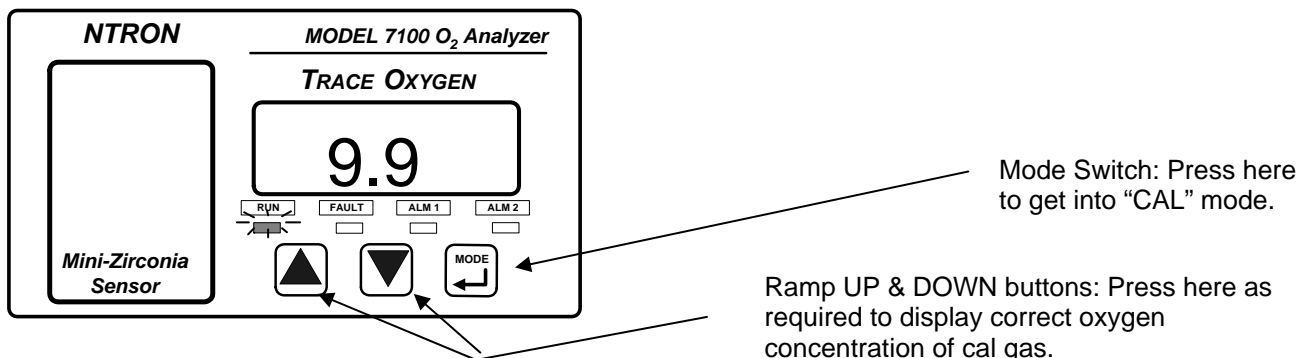

3. "CAL" will be displayed. The Green LED "RUN" will blink fast. Press the UP and Down arrows as needed to show correct PPM oxygen on the display.
4. Press "MODE" button to scroll back to "run" mode. The unit will have to scroll past the Alarm 1, Alarm 2 and Fault modes before returning to normal "RUN" mode.
5. The Green LED "RUN" will blink slowly in "RUN"

**NOTE: DO NOT CALIBRATE WITH A ZERO GAS. SETTING ZERO WILL CREATE ERROR IN THE MEASUREMENT CALCULATIONS!**



## SECOND POINT CALIBRATION

1. Connect a calibrated standard gas to the sensor. Regulate the pressure to 1-3 psig. Enter "CAL" mode by pressing "MODE" .

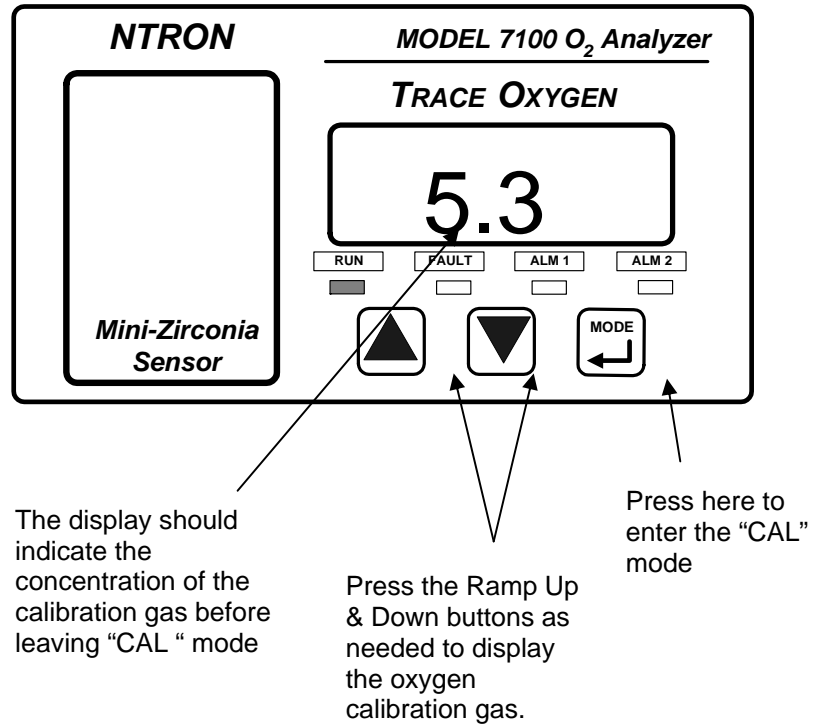

## Understanding the Digital Display

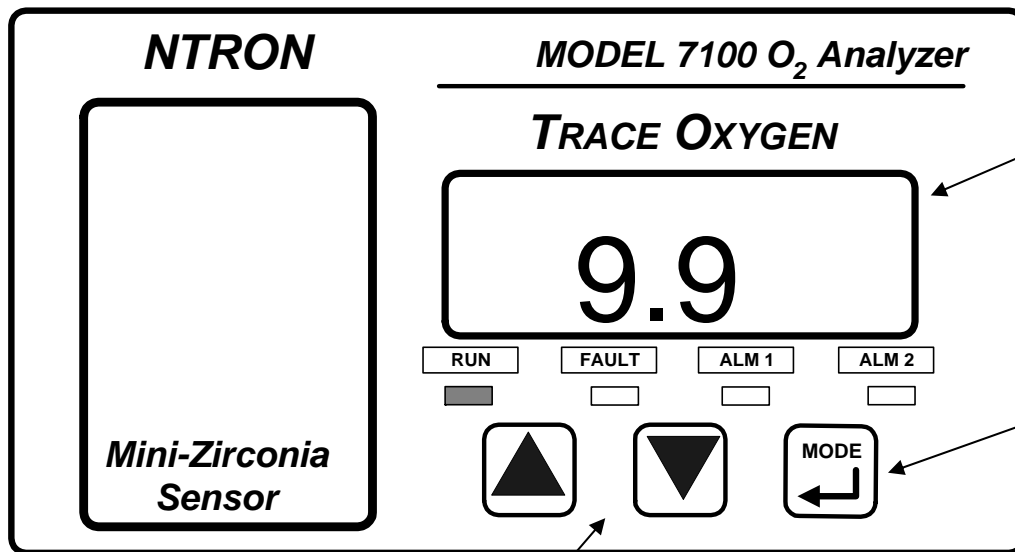

The numeric display features large, super bright LEDs. There are two modes of display: When the analyzer is in the "out of normal operating range" measurement range, the display will flash bright to dim.

The MODE button is used to scroll through the menu options. Modes include: RUN, SET ALARM 1, SET ALARM 2, FAULT,... return to RUN.

The Ramp UP & Ramp DOWN buttons are used to increment or decrement values on the display.